



ÍNDICE

SMART TOILETS

In-Wash	4
Inspira In-wash® In-Tank®	5

COLECCIONES DE BAÑO

Inspira	7
Khroma	10
Meridian	11
The Gap	14

LAVABOS

Inspira	19
Murales o Sobremueble	20
Sobre encimera	21
Encimera - Bajo encimera	22

MUEBLES DE BAÑO

Prisma	24
Dama	25
Mini	25

GRIFERÍA

Smart Shower	27
Loft-E	28
Thesis	29
L90	30
Naia	31
Lanta	32
Atlas	33
Targa	34
L20	35
Loft	36
Florentina	37
Element	38
Grifería termostática	39
Grifería para cocina	40
Evolution	41
Columnas de ducha	42
Duchas de mano	43
Kits de ducha	43
Rociadores	44
Complementos de ducha	45
Sifones	46
Tomas de agua	47
Desagües click-clack	48

TINAS

Newcast	49
---------	----

ACCESORIOS

Select	51
--------	----

SISTEMAS DE INSTALACIÓN

Duplo	54
Placas de accionamiento	55

ESPACIOS PÚBLICOS

Urinarios	58
Fluxores para inodoro	59
Lavadero	60

ANEXOS

Anexo 1	62
Complementos de instalación	
Anexo 2	64
Distancias de instalación en inodoros	

SMART TOILETS



Inodoros con función de lavado con agua y secado integrada. Máxima higiene y bienestar.

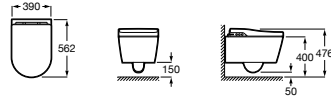

In-wash® suspendido **A803 060 001** **S** \$ 54,820.00

SMART TOILET SUSPENDIDO RIMLESS CON SALIDA A PARED. INCLUYE TAPA Y ASIENTO CON FUNCIÓN LAVADO Y SECADO. NECESITA TOMA DE RED. COLOR: BLANCO.

390 X 562 MM

SE RECOMIENDA INSTALACIÓN CON DUPLO WC SMART (A890 090 800).

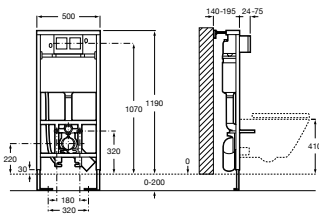

Duplo WC Smart **A890 090 800** \$ 7,280.00

TANQUE EMPOTRABLE DE DOBLE DESCARGA, FLEJO DE ALIMENTACIÓN PARA SMART TOILETS, TUBO CORRUGADO Y ACCESORIOS DE INSTALACIÓN. PROFUNDIDAD MÍNIMA DE FIJACIÓN 140 MM, ALTURA 1,190 MM Y CODO DE EVACUACIÓN 90/110 Ø. MM.

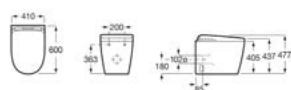

In-Wash® Insignia con In-Tank®

A803 095 001 **N** \$ 147,00.00

SMART TOILET CON FUNCIÓN LAVADO Y SECADO ADOSADO A PARED
RIMLESS VORTEX CON TANQUE DE DOBLE DESCARGA (4.5/3 L)
INTEGRADO Y ASIENTO CALEFACTADO. NECESITA TOMA DE RED.

INCLUYE CODO PARA INSTALACIÓN A 210 MM.

COLECCIONES DE BAÑO



La solución ideal para generar un espacio armónico con productos que comparten un mismo diseño y estilo.

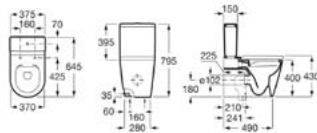

Inspira Round inodoro Rimless dos piezas adosado a muro con salida dual



Taza **A342 526 000** \$ 7,800.00

TAZA RIMLESS ADOSADA A PARED CON SALIDA DUAL PARA INODORO DE TANQUE BAJO. INCLUYE CODO DE EVACUACIÓN Y JUEGO DE FIJACIÓN. COLOR: BLANCO.



Tanque **A341 520 000** \$ 5,700.00

TANQUE DE DOBLE DESCARGA 4.5/3L CON ALIMENTACIÓN INFERIOR PARA INODORO. INCLUYE SISTEMA DE FIJACIÓN, MECANISMO DE ALIMENTACIÓN Y MECANISMO DE DESCARGA. COLOR: BLANCO.



Asiento y tapa **A801 522 00B** \$ 2,500.00

TAPA Y ASIENTO DE SUPRALIT® PARA INODORO CON CAÍDA AMORTIGUADA. COLOR: BLANCO.

TOTAL (Taza + Tanque + Asiento) \$16,000.00

INCLUYE CODO PARA INSTALACIÓN A 210 MM.

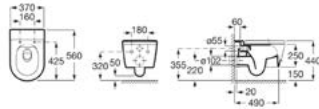

Inspira Round inodoro suspendido Rimless con salida horizontal



Taza

A346 527 000

\$ 8,800.00

TAZA SUSPENDIDA RIMLESS CON SALIDA DUAL. INCLUYE JUEGO DE FIJACIÓN. COLOR: BLANCO.



Tapa y asiento

A801 522 00B

\$ 2,500.00

TAPA Y ASIENTO DE SUPRALIT® PARA INODORO CON CAÍDA AMORTIGUADA. COLOR: BLANCO.

Complementos:



In-Wall Duplo WC

A890 090 020

\$ 10,500.00

BASTIDOR CON TANQUE EMPOTRABLE DE DOBLE DESCARGA PARA INODORO SUSPENDIDO. CODO DE Ø 90/110.



PL1 Dual Blanca

A890 095 000

\$ 1,000.00

PLACA DE ACCIONAMIENTO CON DESCARGA DUAL. COLOR: BLANCO.*

*DISPONIBLE EN OTROS ACABADOS/COLORES

TOTAL (Taza + Asiento + Tanque + Placa) \$ 22,800.00

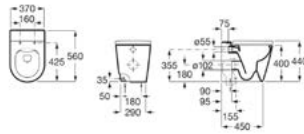

Inspira Round taza Rimless adosada a muro con salida dual



Taza

A347 526 000

\$ 9,000.00

TAZA ADOSADA A PARED CON SALIDA DUAL PARA INODORO DE TANQUE ALTO, TANQUE EMPOTRABLE O FLUXOR. INCLUYE JUEGO DE FIJACIÓN. COLOR: BLANCO.



Asiento y tapa

A801 522 00B

\$ 2,500.00

TAPA Y ASIENTO DE SUPRALIT® PARA INODORO CON CAÍDA AMORTIGUADA. COLOR: BLANCO.

Complementos:



In-Wall Basic Tank

A890 090 200

\$ 4,050.00

TANQUE EMPOTRABLE CON DOBLE DESCARGA PARA INODORO DE TANQUE ALTO O EMPOTRABLE.



PL1 Dual Blanca

A890 095 000

\$ 1,000.00

PLACA DE ACCIONAMIENTO CON DESCARGA DUAL. COLOR: BLANCO.*

*DISPONIBLE EN OTROS ACABADOS/COLORES

TOTAL (Taza + Asiento + Tanque + Placa) \$ 16,550.00

NO INCLUYE CODO O MANGUITO RECTO



Khroma inodoro largo de porcelana

	Taza	A342 657 000	\$ 13,220.00	TAZA DE SALIDA DUAL, ADOSADA A PARED, CON CODO, FIJACIÓN CODO A PARED Y JUEGO DE FIJACIÓN. COLOR: BLANCO.
	Tanque	A341 650 000	\$ 8,610.00	TANQUE CON MECANISMO DE DOBLE DESCARGA 3/6 LITROS. COLOR: BLANCO.
	Silver Gray	A801 65A FIT	\$ 3,290.00	RESPALDO FRONTAL PARA TANQUE.
	Passion Red	A801 65A F3T		
	Silver Gray	A801 652 FIT	\$ 3,290.00	TAPA Y ASIENTO PARA INODORO CON CAÍDA AMORTIGUADA.
	Passion Red	A801 652 F3T		
TOTAL (Taza + Tanque + Respaldo + Asiento)			\$ 28,410.00	

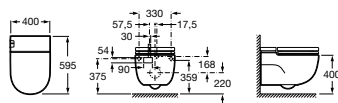

In-Tank suspendido **A893 301 000** **H** \$ 82,250.00

INODORO SUSPENDIDO CON TANQUE INTEGRADO. INCLUYE SOPORTE EN "L" PARA INSTALACIÓN MURAL, TAPA Y ASIENTO. NECESITA TOMA DE RED. COLOR: BLANCO.

400 X 595 X 400 MM

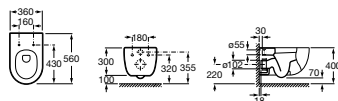

Meridian suspendido con salida horizontal



Taza **A346 247 000** **H** \$5,790.00

TAZA SUSPENDIDA CON SALIDA HORIZONTAL. INCLUYE JUEGO DE FIJACIÓN. COLOR: BLANCO.



Tapa y asiento **A801 2A2 00B** \$ 2,700.00

TAPA Y ASIENTO DE SUPRALIT® PARA INODORO CON CAÍDA AMORTIGUADA. COLOR: BLANCO.

Complementos:



In-Wall Duplo WC **A890 090 020** \$ 10,500.00

BASTIDOR CON TANQUE EMPOTRABLE DE DOBLE DESCARGA PARA INODORO SUSPENDIDO. CODO DE Ø 90/110.



PL1 Dual Blanca **A890 095 000** \$ 1,000.00

PLACA DE ACCIONAMIENTO CON DESCARGA DUAL. COLOR: BLANCO.*

*DISPONIBLE EN OTROS ACABADOS/COLORES

TOTAL (Taza + Asiento + Tanque + Placa) \$ 19,990.00



Silent Wall **A890 063 000** \$ 600.00

JUNTA AMORTIGUADORA DE RUIDO PARA INODORO Y BIDÉ SUSPENDIDO.

Meridian

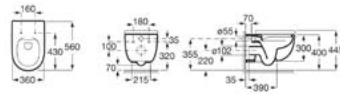

Meridian suspendido Rimless con salida horizontal



Taza

A346 24L 000

\$14,700.00

TAZA SUSPENDIDA RIMLESS CON SALIDA HORIZONTAL. INCLUYE JUEGO DE FIJACIONES. COLOR: BLANCO.



Tapa y asiento

A801 2A2 00B

\$ 2,700.00

TAPA Y ASIENTO DE SUPRALIT® PARA INODORO CON CAÍDA AMORTIGUADA. COLOR: BLANCO.

Complementos:



In-Wall Duplo WC

A890 090 020

\$ 10,500.00

BASTIDOR CON TANQUE EMPOTRABLE DE DOBLE DESCARGA PARA INODORO SUSPENDIDO. CODO DE Ø 90/110.



PL1 Dual Blanca

A890 095 000

\$ 1,000.00

PLACA DE ACCIONAMIENTO CON DESCARGA DUAL. COLOR: BLANCO.*

*DISPONIBLE EN OTROS ACABADOS/COLORES

TOTAL (Taza + Asiento + Tanque + Placa) \$ 28,900.00



Silent Wall

A890 063 000

\$ 600.00

JUNTA AMORTIGUADORA DE RUIDO PARA INODORO Y BIDÉ SUSPENDIDO.

Meridian

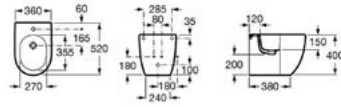

Meridian bidé compacto a muro



Bidé

A357 247 000

\$ 5,750.00

BIDÉ COMPACTO ADOSADO A PARED SIN TAPA. INCLUYE JUEGO DE FIJACIÓN. NO INCLUYE GRIFERÍA. COLOR: BLANCO.



Tapa para bidé

A806 2AC 004

\$ 2,700.00

TAPA PARA BIDÉ COMPACTO CON CAÍDA AMORTIGUADA. COLOR: BLANCO.

TOTAL (Taza + Asiento)

\$ 8,450.00



Aqua sifón curvo

A506 402 210

SIFÓN CURVO AQUA 1/4" PARA BIDÉ INCLUIDO.

The Gap

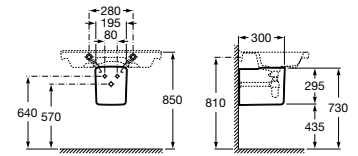
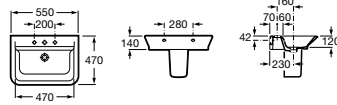

The Gap lavabo

A327 475 000

\$ 3,750.00

The Gap semipedestal

A337 471 000

\$ 3,700.00

LAVABO DE PORCELANA MURAL, SOBRE ENCIMERA. CON JUEGO DE FIJACIÓN. COLOR: BLANCO.

SEMPIEDESTAL PARA LAVABO DE PORCELANA. COLOR: BLANCO.

195 X 300 MM

550 X 470 MM

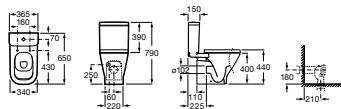

The Gap Square inodoro de tanque bajo



Taza

A342 477 000

\$ 8,800.00

TAZA CON SALIDA HORIZONTAL PARA INODORO DE TANQUE BAJO. SISTEMA DE DESCARGA: ARRASTRE. COLOR: BLANCO.



Tanque

A341 470 000

\$ 4,700.00

TANQUE DE DOBLE DESCARGA 4.5/3L CON ALIMENTACIÓN INFERIOR PARA INODORO. INCLUYE SISTEMA DE FIJACIÓN, MECANISMO DE ALIMENTACIÓN Y MECANISMO DE DESCARGA. COLOR: BLANCO.



Asiento y tapa

A801 472 004

\$ 3,150.00

TAPA Y ASIENTO PARA INODORO CON CAÍDA AMORTIGUADA. FORMA: CUADRADA. COLOR: BLANCO.

TOTAL (Taza + Tanque + Asiento)

\$ 16,650.00

NO INCLUYE CODO O MANGUITO RECTO.

The Gap

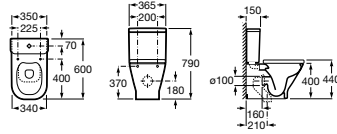

The Gap Square inodoro compacto de tanque bajo



Taza **A342 737 00H** \$ 8,900.00

TAZA COMPACTA RIMLESS DE SALIDA DUAL, ADOSADA A PARED. SISTEMA DE DESCARGA: ARRASTRE. COLOR: BLANCO.



Tanque **A341 730 000** \$ 6,600.00

TANQUE DE DOBLE DESCARGA 4/2L CON ALIMENTACIÓN INFERIOR PARA INODORO COMPACTO. INCLUYE SISTEMA DE FIJACIÓN, MECANISMO DE ALIMENTACIÓN Y MECANISMO DE DESCARGA. COLOR: BLANCO.



Asiento y tapa **A801 732 004** \$ 4,000.00

TAPA Y ASIENTO PARA INODORO COMPACTO CON CAÍDA AMORTIGUADA. COLOR: BLANCO.

TOTAL (Taza + Tanque + Asiento) \$19,500.00

INCLUYE CODO PARA INSTALACIÓN A 210 MM.

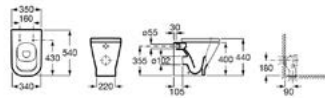

The Gap Square taza adosada a pared



Taza **A347 477 000** \$ 10,100.00

TAZA ADOSADA A PARED CON SALIDA DUAL PARA INODORO DE TANQUE ALTO, TANQUE EMPOTRABLE O FLUXOR. COLOR: BLANCO.



Asiento y tapa **A801 472 004** \$ 3,150.00

TAPA Y ASIENTO PARA INODORO CON CAÍDA AMORTIGUADA. COLOR: BLANCO.

Complementos:



In-Wall Basic Tank **A890 090 200** \$ 4,050.00

TANQUE EMPOTRABLE CON DOBLE DESCARGA PARA INODORO DE TANQUE ALTO O EMPOTRABLE.



PLI Dual Blanca **A890 095 000** \$ 1,000.00

PLACA DE ACCIONAMIENTO CON DESCARGA DUAL. COLOR: BLANCO.*

*DISPONIBLE EN OTROS ACABADOS/COLORES

TOTAL (Taza + Asiento + Tanque + Placa) \$ 18,300.00

NO INCLUYE CODO O MANGUITO RECTO

The Gap

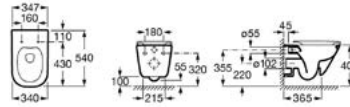

The Gap Square inodoro suspendido rimless



Taza **A346 47L 000** \$ 9,800.00

TAZA SUSPENDIDA RIMLESS CON FIJACIONES OCULTAS Y SALIDA HORIZONTAL. COLOR: BLANCO. PARA LA INSTALACIÓN DE INODOROS SUSPENDIDOS SE REQUIERE UN SISTEMA DE INSTALACIÓN ROCA COMPATIBLE.



Asiento y tapa **A801 472 004** \$ 3,150.00

TAPA Y ASIENTO PARA INODORO CON CAÍDA AMORTIGUADA. COLOR: BLANCO.

Complementos:



In-Wall Duplo WC **A890 090 020** \$ 10,500.00

BASTIDOR CON TANQUE EMPOTRABLE DE DOBLE DESCARGA PARA INODORO SUSPENDIDO. CODIGO DE Ø 90/110.



PL1 Dual Blanca **A890 095 000** \$ 1,000.00

PLACA DE ACCIONAMIENTO CON DESCARGA DUAL. COLOR: BLANCO.*

*DISPONIBLE EN OTROS ACABADOS/COLORES

TOTAL (Taza + Asiento + Tanque + Placa) \$ 24,450.00

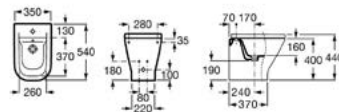

The Gap Square bidé compacto



Bidé **A357 477 000** \$ 5,500.00

BIDÉ COMPACTO ADOSADO A PARED Y TAPA CON CAÍDA AMORTIGUADA. NO INCLUYE GRIFERÍA. COLOR: BLANCO.



Tapa para bidé **A806 472 004** \$ 3,500.00

TAPA DE SUPRALIT® PARA BIDÉ CON CAÍDA AMORTIGUADA. COLOR: BLANCO.

TOTAL (Taza + Asiento) \$ 9,000.00



Aqua sifón curvo **A506 402 210**
SIFÓN CURVO AQUA 1/4" PARA BIDÉ INCLUIDO.

The Gap

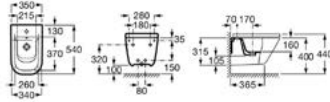

The Gap Square bidé compacto



Bidé

A357 475 000

\$ 4,650.00

BIDÉ SUSPENDIDO SIN TAPA. NO INCLUYE GRIFERÍA. COLOR: BLANCO. PARA LA INSTALACIÓN DE BIDÉS SUSPENDIDOS SE REQUIERE UN SISTEMA DE INSTALACIÓN ROCA COMPATIBLE.



Tapa

A806 472 004

\$ 2,800.00

TAPA PARA BIDÉ CON CAÍDA AMORTIGUADA. COLOR: BLANCO.

Complementos:



In-Wall Duplo bidé

A890 091 200

\$ 5,750.00

BASTIDOR EMPOTRADO PARA BIDÉ SUSPENDIDO. PERFIL METÁLICO CON CAPACIDAD DE RESISTENCIA DE 400 KG. PATAS AJUSTABLES DE 0-200 MM. CONEXIÓN HIDRÁULICA AJUSTABLE.



Aqua sifón

A506 401 814

\$ 1,200.00

SIFÓN BOTELLA DE 1 1/4" PARA BIDÉ. TUBO DE 300 MM.

TOTAL (Bidé + Tapa + Bastidor + Sifón) \$ 14,400.00

LAVABOS



Las lavabos Roca se adaptan a una gran variedad de estilos para el baño. Fabricados con los materiales más resistentes, los lavabos Roca cumplen con los más altos estándares de calidad.

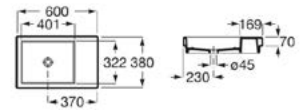
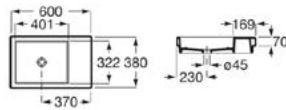

Horizon Skyline

A327 275 00B

N \$ 7,500.00

LAVABO DE PORCELANA DE ENCIMERA. NO INCLUYE GRIFERÍA. REPISA INTEGRADA. ASIMÉTRICO. COLOR: BLANCO.

600 X 380 MM

Horizon Skyline

A327 275 08B

N \$ 7,700.00

LAVABO DE PORCELANA DE ENCIMERA. NO INCLUYE GRIFERÍA. REPISA INTEGRADA. ASIMÉTRICO. COLOR: NEGRO.

600 X 380 MM

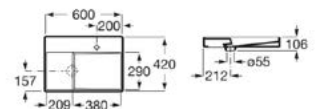
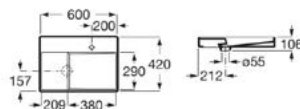

Horizon View

A327 274 00B

N \$ 7,000.00

LAVABO DE SOBRE ENCIMERA CON ORIFICIO PARA GRIFERÍA. NO INCLUYE GRIFERÍA. REPISA INTEGRADA. COLOR: BLANCO.

600 X 420 MM

Horizon View

A327 530 000

N \$ 7,600.00

LAVABO DE SOBRE ENCIMERA CON ORIFICIO PARA GRIFERÍA. NO INCLUYE GRIFERÍA. REPISA INTEGRADA. COLOR: BLANCO.

600 X 420 MM

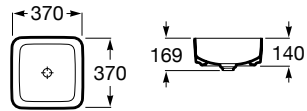

Inspira Square

A327 532 000

\$ 10,700.00

LAVABO FINECERAMIC®. INCLUYE DESAGÜE UNIVERSAL CON TAPÓN FIJO ABIERTO DE PORCELANA Ø 72 MM. COLOR: BLANCO.

370 X 370 MM

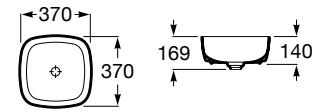

Inspira Soft

A327 502 000

\$ 9,200.00

LAVABO FINECERAMIC®. INCLUYE DESAGÜE UNIVERSAL CON TAPÓN FIJO ABIERTO DE PORCELANA Ø 72 MM. COLOR: BLANCO.

370 X 370 MM

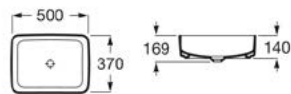

Inspira Square

A327 530 000

\$ 15,300.00

LAVABO FINECERAMIC®. INCLUYE DESAGÜE UNIVERSAL CON TAPÓN FIJO ABIERTO DE PORCELANA Ø 72 MM. COLOR: BLANCO.

500 X 370 MM

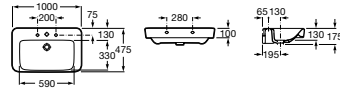

Senso Square lavabo

A327 51M 000

\$ 3,580.00

DE PORCELANA. CON SET DE MONTAJE. COLOR: BLANCO.

1000 X 475 MM

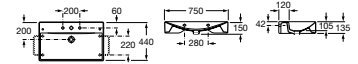

Diverta lavabo

A327 110 000

\$ 7,170.00

DE PORCELANA ESMALATADO 4 CARAS. CON JUEGO DE FIJACIÓN. COLOR: BLANCO.

750 X 440 X 135 MM



Prisma lavabo

A327 542 000

\$ 4,480.00

ASIMÉTRICO DE PORCELANA. TINA IZQUIERDA. CON JUEGO DE FIJACIÓN. COLOR: BLANCO.

1100 X 450 MM

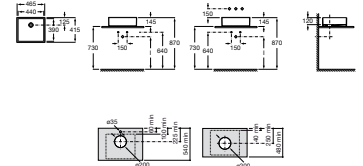
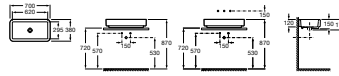

Element lavabo

A327 572 000

\$ 10,170.00

DE PORCELANA. COLOR: BLANCO.

700 X 380 X 150 MM

Sofia lavabo

A327 720 000

\$ 8,500.00

DE PORCELANA. ESMALTADO CUATRO CARAS. COLOR: BLANCO.

465 X 415 X 145 MM

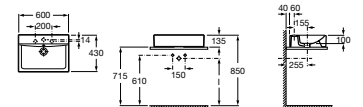
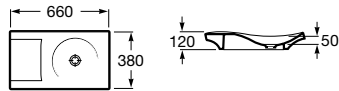

Urbi 2 lavabo

A327 226 000

\$ 7,800.00

DE PORCELANA. COLOR: BLANCO.

630 X 380 MM

Diverta lavabo

A327 11G 000

\$ 6,910.00

DE PORCELANA. ESMALTADO CUATRO CARAS. COLOR: BLANCO.

600 X 430 X 135 MM

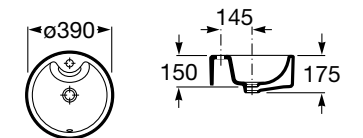

Terra lavabo

A327 22T 000

\$ 4,580.00

DE PORCELANA. 1 AGUJERO EN EL CENTRO PARA GRIFERÍA. Ø 390 MM. COLOR: BLANCO.

390 X 390 X 150 MM

Encimera - Bajo encimera

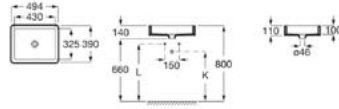

Inspira

A327 536 000

\$ 9,900.00

LAVABO FINECERAMIC® DE BAJO ENCIMERA CON JUEGO DE FIJACIÓN. INCLUYE DESAGÜE. NO INCLUYE SIFÓN. COLOR: BLANCO.

495 X 390 X 138 MM

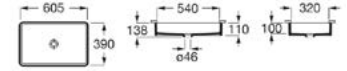

Inspira

A327 535 000

\$ 12,200.00

LAVABO FINECERAMIC® DE BAJO ENCIMERA CON JUEGO DE FIJACIÓN. INCLUYE DESAGÜE. NO INCLUYE SIFÓN. COLOR: BLANCO.

605 X 390 X 138 MM

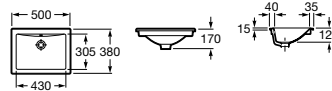

Diverta lavabo

A327 114 000

\$ 7,300.00

DE PORCELANA. DE ENCIMERA/ BAJO ENCIMERA. CON JUEGO DE FIJACIÓN. COLOR: BLANCO.

500 X 380 X 170 MM

MUEBLES DE BAÑO



Las lavabos Roca se adaptan a una gran variedad de estilos para el baño. Fabricados con los materiales más resistentes, los lavabos Roca cumplen con los más altos estándares de calidad.

Muebles Prisma

 Consulta precio especial

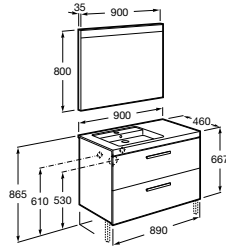

Prisma mueble

A855 937 322

\$ 29,090.00

PACK MUEBLE BASE CON 2 CAJONES, LAVABO TINA IZQUIERDA Y ESPEJO LED. COLOR: BLANCO - FRESNO.

900 X 460 X 667 MM

Complementos opcionales:

Conjunto de dos patas

A816 764 339

\$ 1,440.00

Set de 2 colgadores

A816 761 001

\$ 2,390.00

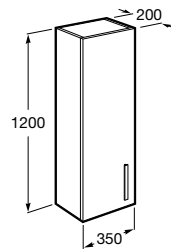

Prisma módulo columna

1 Blanco brillo

A856 887 806

\$ 9,830.00

2 Blanco - Fresno

A856 887 322

Prisma Basic espejo

1200 x 800 mm

A812 262 000

\$ 11,870.00

1000 x 800 mm

A812 260 000

\$ 11,130.00

900 x 800 mm

A812 259 000

\$ 9,900.00

800 x 800 mm

A812 258 000

\$ 8,560.00

600 x 800 mm

A812 257 000

\$ 7,330.00

MÓDULO SEMI COLUMNA REVERSIBLE, CON ESTANTES METÁLICOS REGULABLES EN ALTURA.

350 X 200 X 1200 MM

ESPEJO CON ILUMINACIÓN LED SUPERIOR

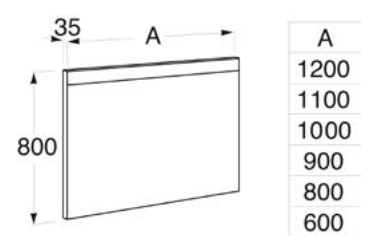

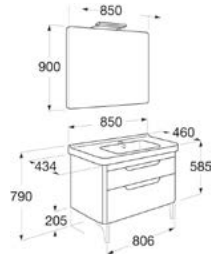

Dama mueble

A855 810 149

\$ 21,900.00

PACK MUEBLE UNIK BASE CON 2 CAJONES, ESPEJO Y APLIQUE DELIGHT. COLOR: KHAKI.

850 X 460 X 667 MM

Complemento opcionales:

Conjunto de dos patas

A816 560 002



\$ 2,060.00

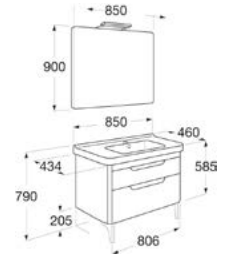

Dama mueble

A855 810 150

\$ 21,900.00

PACK MUEBLE UNIK BASE CON 2 CAJONES, ESPEJO Y APLIQUE DELIGHT. COLOR: MOOD TEKA

850 X 460 X 667 MM

Mini

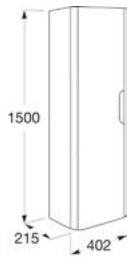

Dama módulo columna

1 Kakhi

A856 628 149

\$ 13,820.00

2 Mood Teka

A856 628 150

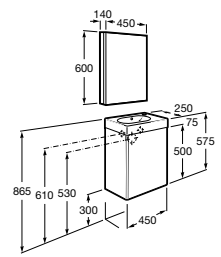

Mini mueble

A855 866 806

\$ 7,300.00

PACK CONJUNTO DE MUEBLE BASE, LAVABO DE SOBREMUEBLE, ARMARIO ESPEJO CON ACABADOS LATERALES A CONJUNT CON EL MUEBLE Y APLIQUE. NO INCLUYE SIFÓN. COLOR: BLANCO BRILLO.

450 X 250 X 575 MM

MÓDULO SEMI COLUMNA REVERSIBLE, CON ESTANTES METÁLICOS REGULABLES EN ALTURA.

402 X 215 X 1500 MM

GRIFERÍAS



Las griferías Roca están disponibles en una amplia gama de diseños y soluciones altamente estéticas y funcionales para tu baño o cocina. Gracias al uso de las mejores materias primas, la grifería Roca ofrece una alta calidad, durabilidad y brillo permanente.

Smart Shower

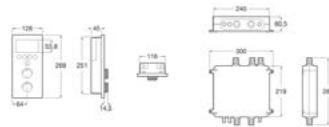

Smart Shower

A5A1 04A C00

\$ 75,800.00

PANEL Y KIT DE INSTALACIÓN SMART SHOWER. MEZCLADOR TERMOSTÁTICO EMPOTRADO 3 VÍAS. ALIMENTACIÓN: CORRIENTE ELÉCTRICA.

Loft - E

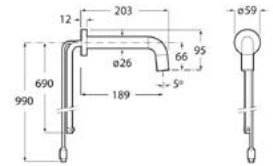
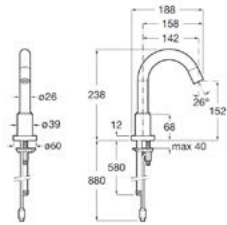

Loft-E

A5A4 243 C00

\$ 12,300.00

GRIFERÍA ELECTRÓNICA PARA LAVABO (UN AGUA) CON SENSOR INTEGRADO EN EL CAÑO. ALIMENTACIÓN CON 4 PILAS ALCALINAS 1.5V LR6 (AA)

Loft-E

A5A5 643 C00

\$ 11,300.00

GRIFERÍA ELECTRÓNICA EMPOTRABLE PARA LAVABO (UN AGUA) CON SENSOR INTEGRADO EN EL CAÑO. ALIMENTACIÓN CON 4 PILAS ALCALINAS 1.5V LR6 (AA)

Grifería Thesis

 Consulta precio especial

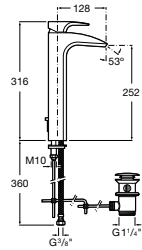

Mezclador de caño alto A5A3 450 C00 \$ 8,610.00

PARA LAVABO. CON LIMITADOR DE CAUDAL A 6 L/MIN, DESAGÜE AUTOMÁTICO Y ENLACES DE ALIMENTACIÓN FLEXIBLES. CROMADO.

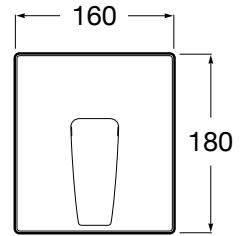

Mezclador empotrable A5A2 B50 C00 \$ 4,430.00

DE BAÑO O DUCHA DE 1/2". CROMADO.
A COMPLETAR CON ROCABOX (A525869403).

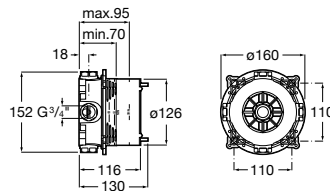

RocaBox A525 869 403 \$ 2,450.00

ROCABOX UNIVERSAL, PARA INSTALACIONES EMPOTRADAS CARTUCHO CERÁMICO.

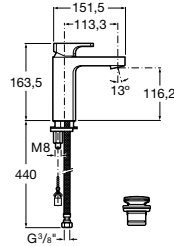

Mezclador monomando A5A3 901 C00 \$ 6,420.00

PARA LAVABO. CUERPO LISO, CON ENLACES DE ALIMENTACIÓN FLEXIBLES. INCLUYE DESAGÜE CLICK-CLACK. CROMADO.

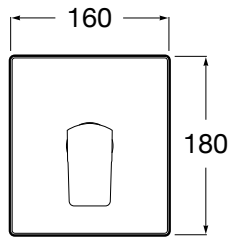

Mezclador empotrable A5A2 B01 C00 \$ 5,220.00

PARA BAÑO O DUCHA. DE 1/2". CROMADO. A COMPLETAR CON ROCABOX (A525869403).

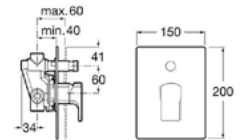

Mezclador empotrable A5A0 601 C00 \$ 6,300.00

PARA BAÑO O DUCHA. DE 1/2". CON INVERSOR AUTOMÁTICO. CROMADO. A COMPLETAR CON ROCABOX (A525869403).

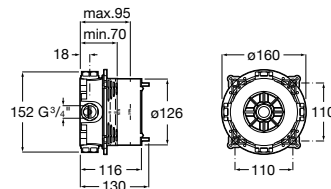

RocaBox A525 869 403 \$ 2,450.00

ROCABOX UNIVERSAL, PARA INSTALACIONES EMPOTRADAS CARTUCHO CERÁMICO.

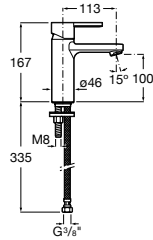

Mezclador monomando A5A3 296 C00 \$ 1,980.00

PARA LAVABO. CON AIREADOR, CUERPO LISO Y ENLACES DE ALIMENTACIÓN FLEXIBLES. INCLUYE DESAGÜE CLICK-CLACK. APERTURA EN AGUA FRÍA. CROMADO.

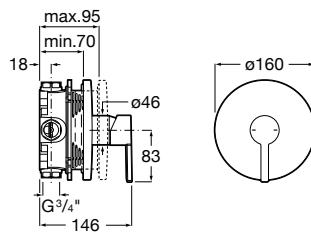

Mezclador empotrable A5A2 B96 C00 \$ 2,500.00

PARA BAÑO O DUCHA. CROMADO. A COMPLETAR CON ROCABOX (A525869403).

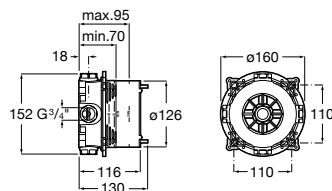

RocaBox A525 869 403 \$ 2,450.00

ROCABOX UNIVERSAL, PARA INSTALACIONES EMPOTRADAS CARTUJO CERÁMICO.

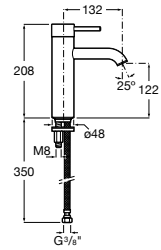
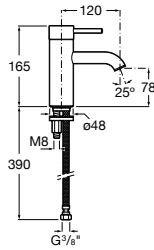

Mezclador monomando

A5A3 A11 C00

\$ 3,910.00

Mezclador monomando

A5A3 C11 C00

\$ 4,710.00

PARA LAVABO. CON AIREADOR, CUERPO LISO Y ENLACES DE ALIMENTACIÓN FLEXIBLES. INCLUYE DESAGÜE CLICK-CLACK. APERTURA EN AGUA FRÍA. CROMADO.

PARA LAVABO. CON AIREADOR, CUERPO LISO Y ENLACES DE ALIMENTACIÓN FLEXIBLES. INCLUYE DESAGÜE CLICK-CLACK. APERTURA EN AGUA FRÍA. CROMADO.

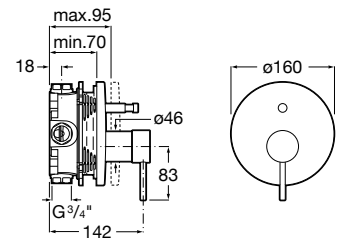
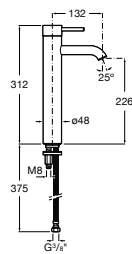

Mezclador caño alto

A5A3 411 C00

\$ 6,430.00

Mezclador empotrable

A5A0 B11 C00

\$ 3,810.00

PARA LAVABO. CON AIREADOR, CUERPO LISO Y ENLACES DE ALIMENTACIÓN FLEXIBLES. INCLUYE DESAGÜE CLICK-CLACK. APERTURA EN AGUA FRÍA. CROMADO.

PARA BAÑO O DUCHA. DE 1/2". CON INVERSOR AUTOMÁTICO. CROMADO. A COMPLETAR CON ROCABOX (A525869403).

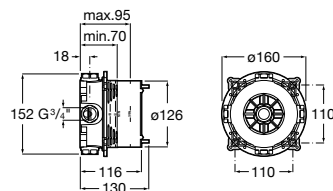

RocaBox

A525 869 403

\$ 2,450.00

ROCABOX UNIVERSAL, PARA INSTALACIONES EMPOTRADAS CARTUCHO CERÁMICO.

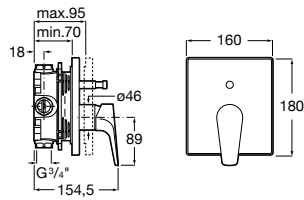

Mezclador empotrable A5A0 B90 C00 \$ 2,900.00

PARA BAÑO-DUCHA. DE 1/2". CON AIREADOR AUTOMÁTICO. W CROMADO A COMPLETAR CON ROCABOX (A525869403).

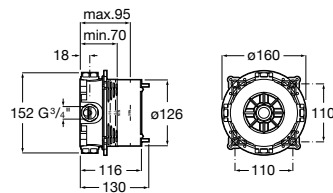

RocaBox A525 869 403 \$ 2,450.00

ROCABOX UNIVERSAL, PARA INSTALACIONES EMPOTRADAS CARTUCHO CERÁMICO.

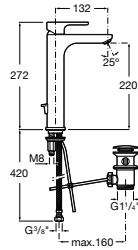

Mezclador monomando A5A3 C09 C00 \$ 3,950.00

CAÑO ALTO. PARA LAVABO. CON MANETA EXTRA-LARGA, DESAGÜE AUTOMÁTICO, AIREADOR Y ENLACES DE ALIMENTACIÓN FLEXIBLES. APERTURA EN AGUA FRÍA. CROMADO.

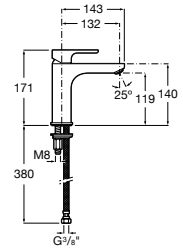

Mezclador monomando A5A3 B09 C00 \$ 2,630.00

CAÑO MEZZO. PARA LAVABO. CON MANETA EXTRA-LARGA, AIREADOR, CUERPO LISO Y ENLACES DE ALIMENTACIÓN FLEXIBLES. APERTURA EN AGUA FRÍA. CROMADO.

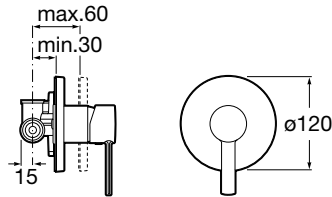

Mezclador empotrable A5A2 209 C00 \$ 3,110.00

PARA BAÑO-DUCHA. DE 1/2". CROMADO

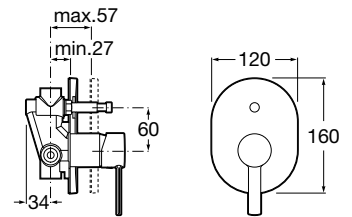

Mezclador empotrable A5A0 609 C00 \$ 4,190.00

PARA BAÑO-DUCHA. DE 1/2". CON INVERSOR AUTOMÁTICO. CROMADO.

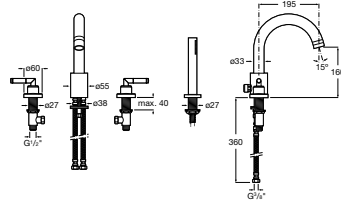

Mezcladora para baño

A5A0 951 C00

\$ 14,800.00

CON CAÑO ALTO CENTRAL, INVERSOR PARA BAÑO, DUCHA DE MANO Y FLEXIBLE DE 1,75 M. CROMADO.

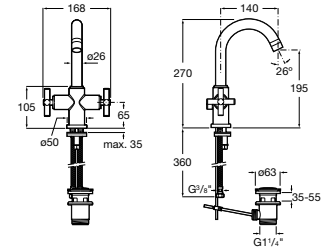

Mezclador bimando

A5A3 043 C00

\$ 8,470.00

PARA LAVABO. CON CAÑO GIRATORIO, AIREADOR, DESAGÜE AUTOMÁTICO Y ENLACES DE ALIMENTACIÓN FLEXIBLES. CROMADO.

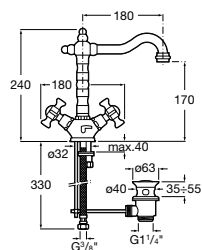

Mezcladora bimando

A507 211 9A0

\$ 5,470.00

PARA LAVABO. CON CAÑO ALTO GIRATORIO, AIREADOR, DESAGÜE AUTOMÁTICO Y ENLACES DE ALIMENTACIÓN FLEXIBLES. CROMADO.

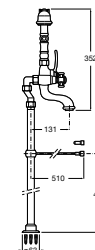
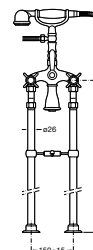

Mezclador exterior

A506 222 3A0

\$ 23,250.00

PARA BAÑO-DUCHA. CON INVERSOR MANUAL, DUCHA DE MANO, FLEXIBLE DE 1.50 M Y COLUMNAS VERTICALES DE ALIMENTACIÓN. CROMADO.

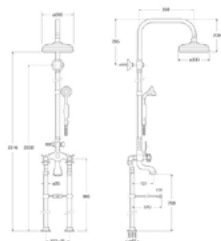

Mezcladora exterior

A506 222 4A0

\$ 35,710.00

PARA BAÑO-DUCHA. CON COLUMNAS DE ALIMENTACIÓN, DUCHA DE MANO Y ROCIADOR ALTO GRAN CAUDAL. CROMADO.

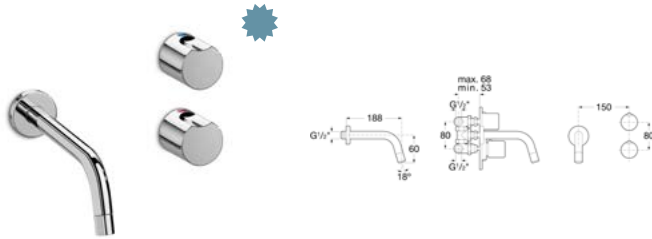

Mezclador empotrable **A5A3 562 C00** \$ 4,800.00

PARA LAVABO. CON AIREADOR. BIMANDO 1/2 VUELTA. CROMADO.

Grifería termostática

T-1000

 Consulta precio especial

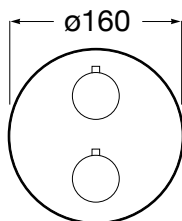

Mezclador empotrable

A5A2 C09 C00

\$ 6,280.00

TERMOSTÁTICO. PARA BAÑO O DUCHA. CROMADO.
A COMPLETAR CON ROCABOX (A525869403).

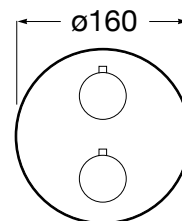

Mezclador empotrable

A5A0 C09 C00

\$ 6,280.00

TERMOSTÁTICO. PARA BAÑO-DUCHA. CON DESVIADOR-REGULADOR DE CAUDAL. CROMADO.
A COMPLETAR CON ROCABOX (A525869403).

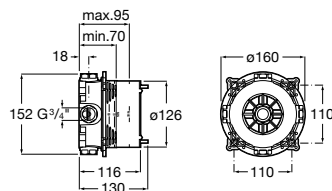

RocaBox

A525 869 403

\$ 2,450.00

ROCABOX UNIVERSAL, PARA INSTALACIONES EMPOTRADAS CARTUCHO CERÁMICO.

Evolution

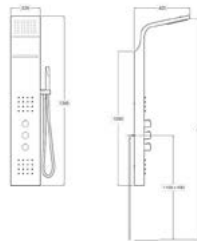

Evolution

A2H0 416 000

\$ 20,850.00

COLUMNA DE HIDROMASAJE TERMOSTÁTICA, JETS INTEGRADOS.
INCLUYE DUCHA DE MANO, SOPORTE Y FLEXIBLE NEO-FLEX SATINADO
DE 1.75 M. ACABADO: ACERO INOXIDABLE.



Index-T Switch

A5A9 J09 C00 **N** \$ 25,500.00

COLUMNA DE DUCHA TERMOSTÁTICA CON REPISA. INCLUYE ROCIADOR Ø300 MM DE 2 FUNCIONES. FLEXIBLE SATINADO PVC 1.50M Y DUCHA DE MANO PLENUM GO 120 MM - 3 FUNCIONES.

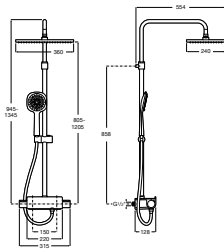

Deck-T Square

A5A9 C88 C00

\$ 15,000.00

COLUMNA DE DUCHA TERMOSTÁTICA CON REPISA. ALTURA REGULABLE DE 80 A 120 CM. INCLUYE: ROCIADOR ORIENTABLE, DUCHA DE MANO SENSUM ROUND Ø 130 MM CON 4 FUNCIONES, FLEXIBLE DE 2 M. EN PVC SATINADO Y SOPORTE ARTICULADO REGULABLE EN ALTURA. CROMADO.

Duchas de mano

 Consulta precio especial

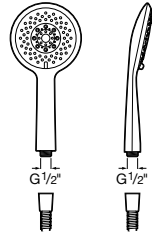

Sensum Round

A5B9 107 C00

\$ 870.00

DUCHA DE MANO Ø 130 MM. 2 FUNCIONES RAIN Y NIGHTRAIN. CROMADO.



Stella

A5B9 B03 C00

\$ 470.00

DUCHA DE MANO Ø 100 MM. 1 FUNCIÓN: RAIN. CROMADO.

Rociadores

 Consulta precio especial



Rainsense rociador **A5B3 050 C00** \$ 7,050.00

CUADRADO. 360 X 240 MM. PUEDE INSTALARSE EN LA PARED O EN EL TECHO. ABS CROMADO. NO INCLUYE BRAZO.

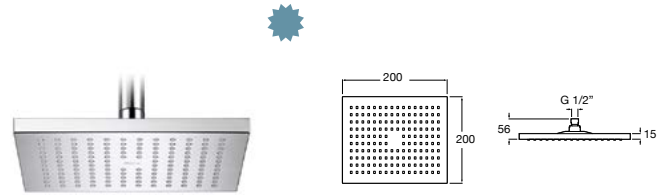

Rainsense rociador **A5B2 350 C00** \$ 2,470.00

CUADRADO. 200 X 200 MM. PUEDE INSTALARSE EN LA PARED O EN EL TECHO. ABS CROMADO.



Rainsense rociador **A5B2 150 C00** \$ 2,200.00

CIRCULAR Ø 200 MM. ORIENTABLE. PUEDE INSTALARSE EN LA PARED O EN EL TECHO. ABS CROMADO. NO INCLUYE BRAZO.



Wall brazo a muro **A5B0 250 C00** \$ 1,470.00

PARA ROCIADOR. LONGITUD: 400 MM.

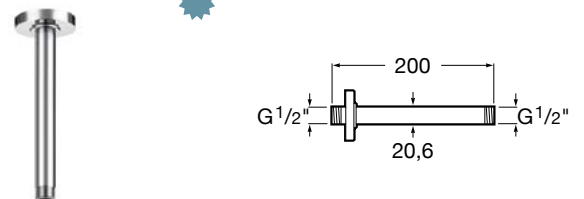

Wall brazo a techo **A5B0 550 C00** \$ 1,780.00

PARA ROCIADOR REDONDO. LONGITUD: 200 MM.



Wall barra de ducha **A5B0 404 C00** \$ 1,240.00

LONGITUD: 600 MM. CON SOPORTE REGULABLE PARA DUCHA DE MANO.

Sifones



Aqua sifón

A506 401 614

\$ 1,000.00

BOTELLA 1 1/4" PARA LAVABO. TUBO DE 250 MM.



Aqua sifón

A506 401 814

\$ 1,200.00

BOTELLA DE 1 1/4" PARA BIDÉ. TUBO DE 300 MM.



Minimal sifón

A506 403 810

\$ 3,000.00

BOTELLA DE 1 1/4" PARA LAVABO. TUBO DE 300 MM.



Aqua toma de agua **AG00 837 00R** \$ 370.00

DE 1/2". PARA FLEXIBLE DE DUCHA. CROMADA.

Desagües

N NUEVO



Desagüe tapón fijo abierto **A506 403 900** **N** \$ 400.00

Aqua desagüe universal **A505 401 100** \$ 2,100.00

DESAGÜE PARA LAVABO O BIDÉ CON TAPÓN FIJO ABIERTO CROMADO
DIÁMETRO: Ø72 MM.

CLICK-CLACK. TAPÓN CERÁMICO Ø65 MM.

TINAS



Las tinas Roca están concebidas con los mayores estándares de calidad y durabilidad en una variada selección de estilos, materiales y formas.

Bañeras

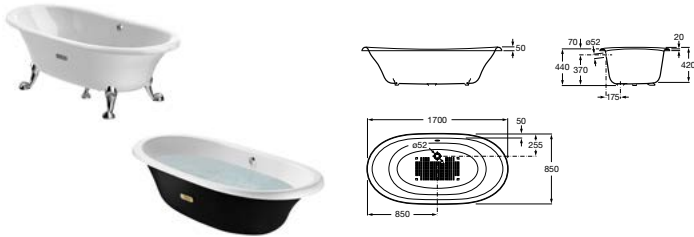

Newcast

Exterior blanco	A233 650 007	\$ 86,100.00
Exterior negro	A233 650 002	\$ 83,200.00

BAÑERA DE HIERRO FUNDIDO INTERIOR BLANCO.
NO INCLUYE OPCIONES DE SOPORTE.

1750 X 850 MM



Opciones de soporte

Eagle	A291 094 000	\$ 26,900.00
-------	---------------------	--------------

CONJUNTO DE 4 PIES. (TIPO GARRA DE ÁGUILA). CROMADO.



Desagüe

A506 403 400	\$ 13,600.00
---------------------	--------------

DESAGÜE CON REBOSADERO Y SIFÓN. CROMADO.

ACCESORIOS



Las colecciones de accesorios de baño Roca son la solución ideal para dar personalidad a tu baño con complementos que comparten una misma línea de diseño y su vez aportan confort a tus rutinas de aseo.

Accesorios Select

 Consulta precio especial



Percha

A816 301 001

\$ 810.00

Jabonera

A816 302 001

\$ 2,270.00

CROMADO.

CROMADO.



Dosificador a muro

A816 304 001

\$ 2,720.00

Portacepillos a muro

A816 303 001

\$ 2,060.00

CROMADO.

CROMADO.



Repisa

A816 306 001

\$ 2,270.00

Toallero lavabo

A816 311 001

\$ 2,580.00

LONGITUD: 600 MM. CROMADO.

LONGITUD: 600 MM. CROMADO.



Portarrollo

A816 307 001

\$ 1,940.00

CROMADO.

SISTEMAS DE INSTALACIÓN



Los sistemas de instalación Roca permiten la instalación de modelos murales de inodoro, bidé, lavabo y urinarios con todas las garantías de estabilidad.

Sistemas de instalación

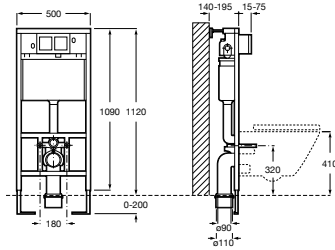

In-Wall Duplo WC

A890 090 020

\$ 10,500.00

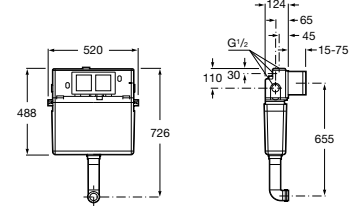

In-Wall Basic Tank

A890 090 200

\$ 4,050.00

BASTIDOR CON TANQUE EMPOTRABLE DE DOBLE DESCARGA PARA INODORO SUSPENDIDO. CODO DE Ø 90/110. COMPATIBLE CON:

Meridian Taza suspendida

A346 247 000

The Gap Taza suspendida RIMLESS

A346 47L 000

TANQUE EMPOTRABLE CON DOBLE DESCARGA PARA INODORO DE TANQUE ALTO O EMPOTRABLE. COMPATIBLE CON:

Meridian Taza a piso

A347 247 000

The Gap Taza a piso

A347 477 000

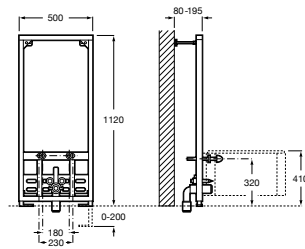

In-Wall Duplo bidé

A890 091 200

\$ 5,750.00

BASTIDOR EMPOTRADO PARA BIDÉ SUSPENDIDO. PERFIL METÁLICO CON CAPACIDAD DE RESISTENCIA DE 400 KG. PATAS AJUSTABLES DE 0-200 MM. CONEXIÓN HIDRÁULICA AJUSTABLE. COMPATIBLE CON:

The Gap bidé suspendido

A357 475 000

Placas de accionamiento PL1 Dual

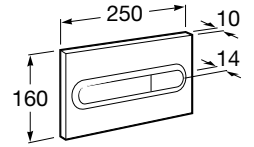

Blanca

A890 095 000

\$ 1,000.00

Cromada

A890 095 001

\$ 1,200.00



Lacada gris

A890 095 002

\$ 1,100.00

Combi

A890 095 005

\$ 950.00

PL2 Dual

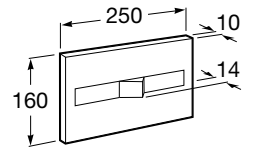

Blanca

A890 096 000

\$ 900.00

Cromada

A890 096 001

\$ 1,200.00



Lacada gris

A890 096 002

\$ 1,100.00

Combi

A890 096 005

\$ 1,100.00

PL4 Dual

 Consulta precio especial

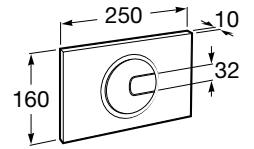

Blanca

A890 098 000

\$ 910.00

Cromada

A890 098 001

\$ 1,560.00



Lacada gris

A890 098 002

\$ 1,560.00

PL5 Dual

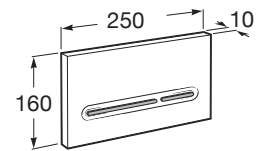

Blanca

A890 099 000

\$ 1,000.00

Cromada

A890 099 001

\$ 1,720.00

ESPACIOS PÚBLICOS



Soluciones concebidas para zonas con gran volumen de tránsito como hospitales, hoteles, aeropuertos, centros comerciales o centros académicos, y aúnan resistencia, seguridad y soluciones específicas para niños y personas con movilidad reducida.

Urinarios

S Stock limitado.

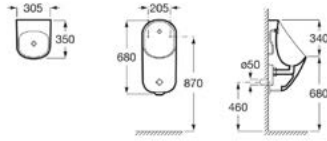

Proton urinario

A359 0J4 000

\$ 10,500.00

ELECTRÓNICO DE PORCELANA CON ENTRADA DE AGUA POSTERIOR Y ALIMENTACIÓN CON 4 PILAS ALCALINAS 1.5 V LR6 (AA).

305 X 680 X 350 MM

INCLUYE KIT DE FIJACIÓN, FLEXIBLE DE ALIMENTACIÓN, SIFÓN, TAPÓN DESAGÜE ANTIVANDÁLICO Y EMISOR - RECEPTOR ELECTRÓNICO.

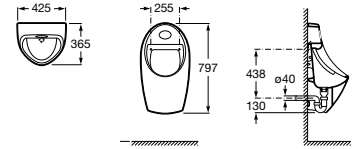

Euret urinario

A359 45E 000



\$ 22,400.00

ELECTRÓNICO DE PORCELANA CON ENTRADA DE AGUA POSTERIOR Y ALIMENTACIÓN CON 4 PILAS ALCALINAS 1.5 V LR6 (AA).

425 X 797 MM

INCLUYE LLAVE DE PASO, SIFÓN KIT DE FIJACIÓN, ENCHUFE DESAGÜE, FLEXIBLE DE ALIMENTACIÓN Y EMISOR-RECEPTOR ELECTRÓNICO.

Fluxores para inodoros

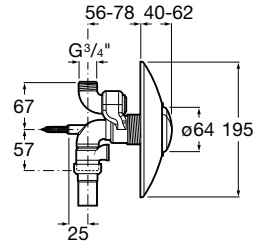
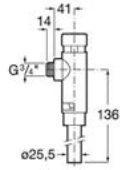
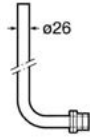

1 Aqua tubo de descarga

A505 521 600

\$ 9,900.00

2 Aqua fluxor exterior

A5A9 577 C00

Aqua fluxor empotrable

A5A9 779 C00

\$ 15,200.00

DE 3/4". DOBLE DESCARGA 6/3 LITROS CON ROSETON. TUBO RECTO PARA INODORO. TECNOLOGÍA TEMPORIZADA. CROMADO .

TUBO DE DESCARGA CURVO. CROMADO.
FLUXOR EXTERIOR DE 3/4" PARA INODORO, CON DOBLE DESCARGA 6/3L Y ACCIONAMIENTO PULSADOR. CROMADO.

Lavadero

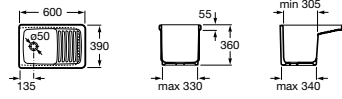

Henares lavadero

A368 951 001

\$ 3,450.00

DE PORCELANA. TIPO DE INSTALACIÓN: ENCASTRADO / DE ENCIMERA.
COLOR: BLANCO.

600 X 390 X 360 MM

Anexo 1

Complementos para instalación

Llaves de escuadra de regulacion

Anexo 2

Distancia de instalación a muro

Khroma

Meridian

In-Tank Meridian

The Gap dos piezas

In-Wash

Meridian y The Gap a piso

Anexo 1

Complementos de instalación



Manguera flexible

TAQHG 3812 500

\$ 100.00

H 3/8" - H 1/2"



Manguera flexible

TAQHG 3838 500

\$ 100.00

H 3/8" - H 3/8"



Reductor

SO 621 12C

\$ 44.00

M 3/8" X H 1/2"



Manguito recto

AV00 078 00R

\$ 500.00

SALIDA HORIZONTAL



Codo

AV00 077 00R

\$ 500.00

PARA EVACUACIÓN VERTICAL DISTANCIA A PARED DE 150 MM



Codo

AV00 079 00R

\$ 500.00

PARA EVACUACIÓN VERTICAL DISTANCIA A PARED DE 120 MM



Complemento opcional AV00 131 00R \$ 200.00

JUEGO DE FIJACIÓN DE CODO A PARED

Llaves de escuadra de regulación

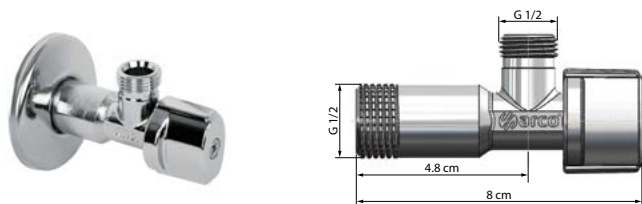

NOV 92 MAC \$ 200.00

ENTRADA 1/2", SALIDA 1/2". SIN TUERCA. CROMO PULIDO.

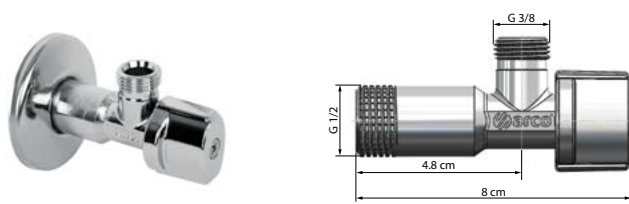

NOV 77 MAC \$ 200.00

ENTRADA 1/2", SALIDA 3/8". SIN TUERCA. CROMO PULIDO.



202 504 \$ 600.00

ENTRADA 1/2", SALIDA 1/2". SIN TUERCA. CROMO PULIDO.



202 511 \$ 800.00

ENTRADA 1/2", SALIDA 3/8". SIN TUERCA. NEGRO MATE.



202 501 \$ 600.00

ENTRADA 1/2", SALIDA 3/8". SIN TUERCA. CROMO PULIDO.

Anexo 2

Khroma

A342 657 000

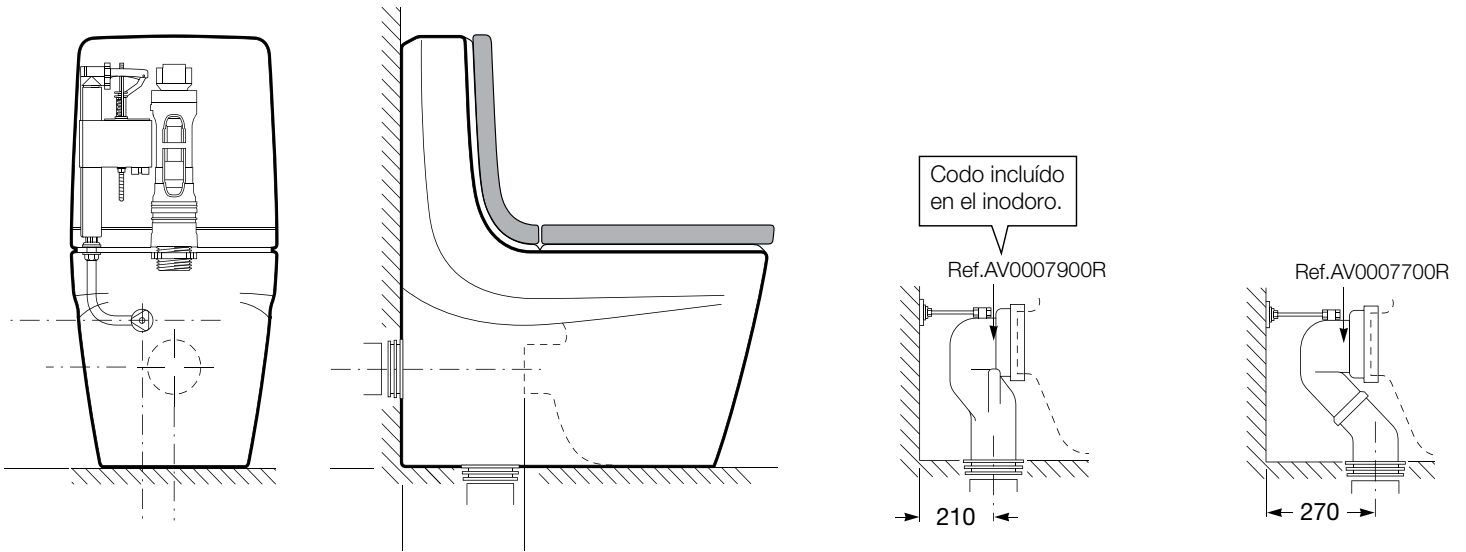

Meridian

A342 248 000

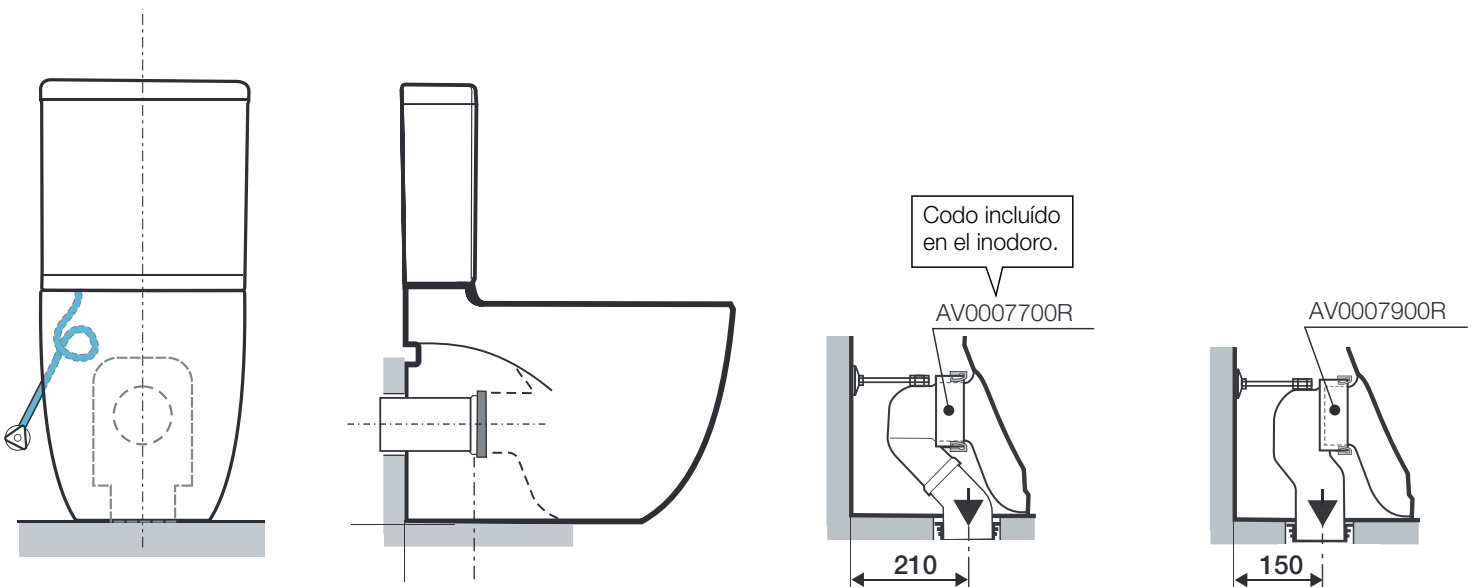

In-Tank Meridian

A893 303 000

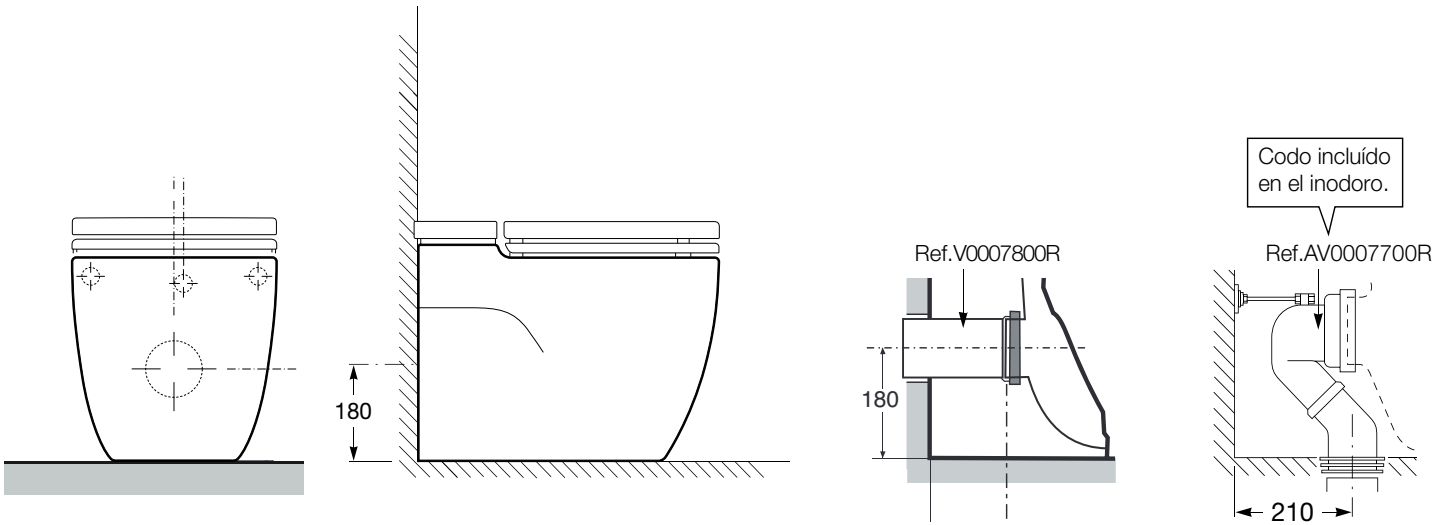

The Gap

A342 477 000

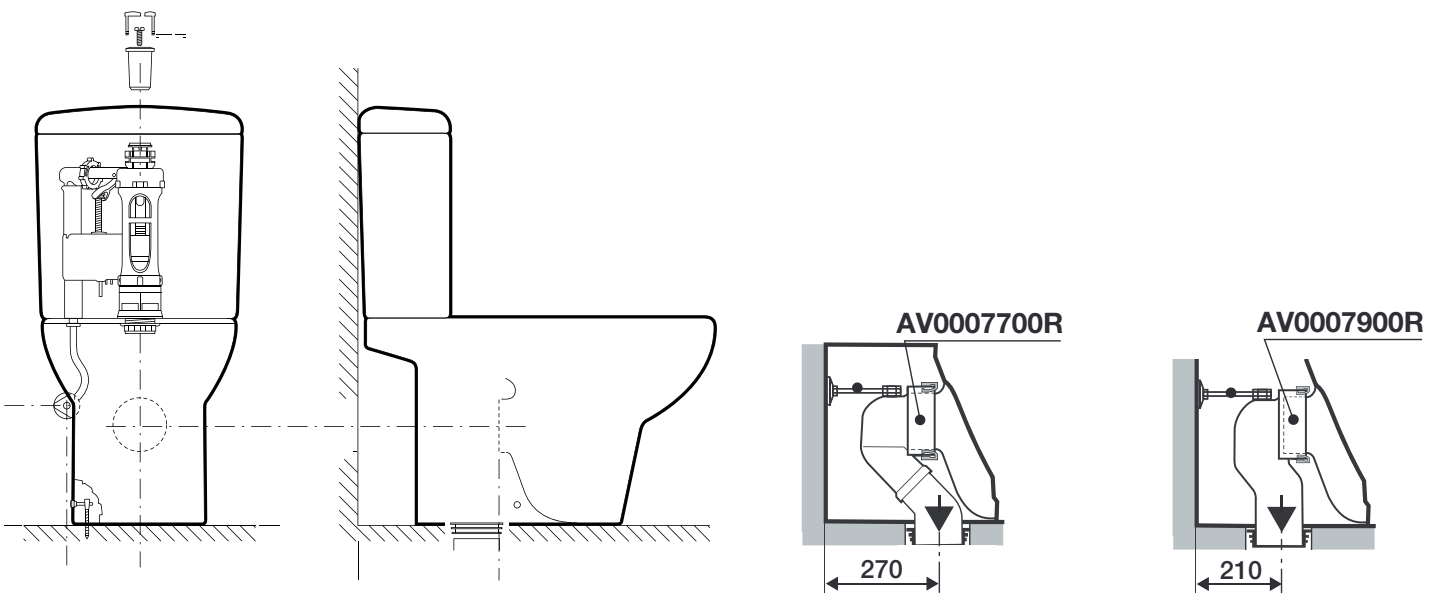

The Gap

A342 737 00H

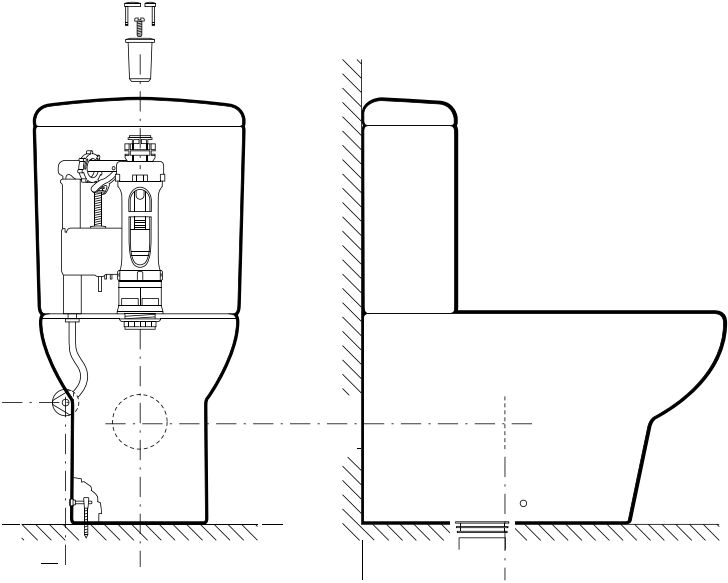

Codo incluido en el inodoro.

AV0007700R

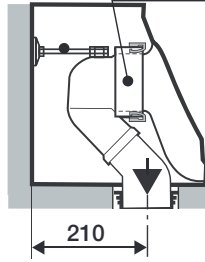

AV0007900R

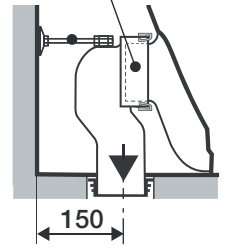

In Wash® Inspira

A803 061 001

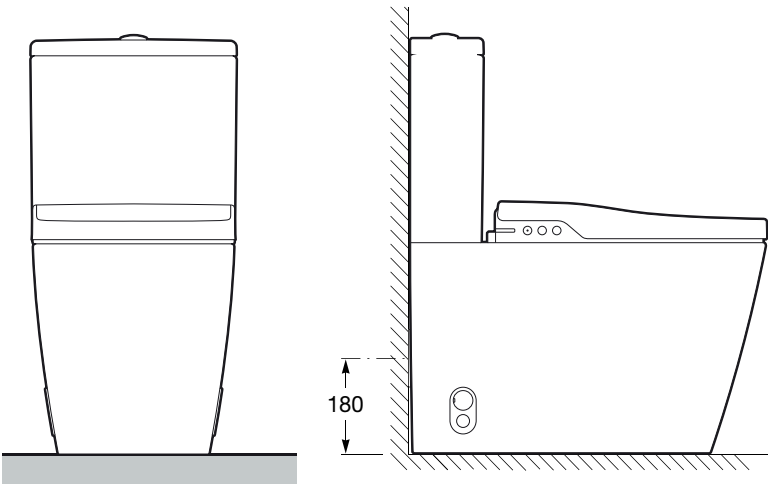

Codo incluido en el inodoro.

Ref.AV0007900R

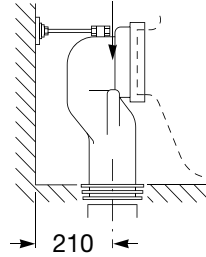

Ref.AV0007700R

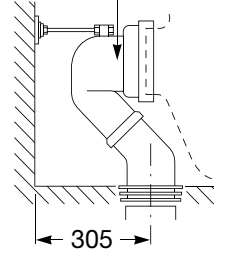

Meridian
The Gap

A347 247 000

A347 477 000

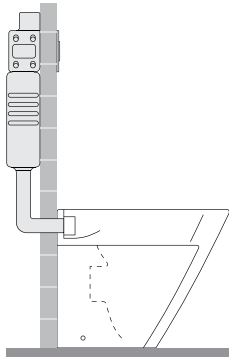

Con cisterna oculta **890 090 200**

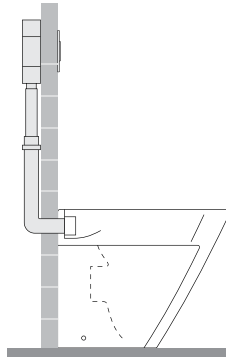

Con fluxor de empotrar **5A9 779 C00**

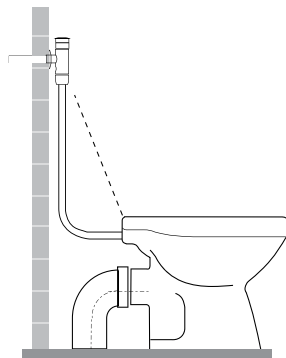
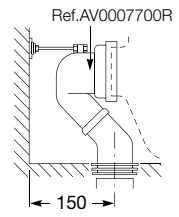
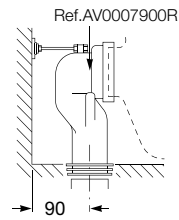

Con fluxor exterior **506 902 110**

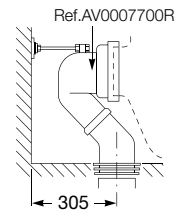

Roca

 **Baníssimo**[®]
fine bath design

atencionalcliente@banissimo.com.mx / banissimo.com.mx
+52 56 1917 2953 / +56 1918 1614