

BATH+

BY COSMIC

BATH+

BY COSMIC

**ACCESSORIES AND
FREE STANDING
ACCESSORIES**

ACCESORIOS Y
COMPLEMENTOS

b-smart P. 4-9

container P. 10-13

diabolo P. 14-25

duo P. 26-45

line P. 46-55

stick P. 56-77

**FURNITURE
MOBILIARIO**

b-best **NEW** P. 78-119

**MIRRORS
ESPEJOS**

mirrors P. 120-125

**LIGHTING
ILUMINACIÓN**

lighting P. 126-129

**PRICE LIST
TARIFA**

price list P. 147-151

BATH+

BY COSMIC

OFFERS USEFUL PRODUCTS FOR TODAY'S BATHROOM. ALL OUR PIECES ARE SIMPLE, FUNCTIONAL AND AFFORDABLE, AS WELL AS BEING UNIVERSALLY ATTRACTIVE.

THE SIMPLICITY OF OUR DESIGNS COMES FROM OUR COMMITMENT TO CREATE PRACTICAL AND ESSENTIAL PRODUCTS MADE WITH ENVIRONMENTALLY FRIENDLY AND AFFORDABLE MATERIALS.

BATH+ ACCESSORIES AND FURNITURE FOR THE BATHROOM HAVE BEEN DESIGNED IN LINE WITH PRACTICALITY AND THE SPACE THEY WILL OCCUPY. WE IMAGINE REAL BATHROOMS LIKE YOURS OR OURS. NO PRETENSIONS AND NO FRILLS.

AT BATH+ WE STRIVE TO RECOVER THE ESSENCE OF OBJECTS THROUGH MATERIALS, TECHNIQUES AND FORMS THAT REFLECT TODAY'S LIFESTYLE: COMFORTABLE PIECES THAT ARE EASY TO INSTALL BUT RETAIN THEIR BEAUTY AND PROVIDE HIGHLY INNOVATIVE SOLUTIONS.

OFRECE PRODUCTOS ÚTILES PARA EL BAÑO DE HOY. TODAS NUESTRAS PIEZAS SON SENCILLAS, FUNCIONALES, ASEQUIBLES Y UNIVERSALMENTE ATRACTIVAS.

LA SENCILLEZ DE NUESTROS DISEÑOS ES FRUTO DE NUESTRO COMPROMISO POR CREAR PRODUCTOS PRÁCTICOS Y SENSATOS, CREADOS CON MATERIALES RESPETUOSOS CON EL ENTORNO Y ASEQUIBLES PARA TODO TIPO DE PERSONAS.

LOS ACCESORIOS Y EL MOBILIARIO PARA EL BAÑO DE BATH+ ESTÁN PENSADOS PARA EL USO Y EL ESPACIO QUE VAN A OCUPAR. IMAGINAMOS BAÑOS REALES COMO EL TUYO O EL NUESTRO. SIN PRETENSIONES NI ARTIFICIOS.

EN BATH+ BUSCAMOS RECUPERAR LA ESENCIA DE LOS OBJETOS CON MATERIALES, TÉCNICAS Y FORMAS ADAPTADAS A LA VIDA ACTUAL. PIEZAS CONFORTABLES, FÁCILES DE INSTALAR, QUE NO RENUNCIAN A LA BELLEZA E INCORPORAN LAS SOLUCIONES MÁS INNOVADORAS.

b-smart accessories are ideal for a practical, simple bathroom. Their design and size is aimed at fulfilling the needs of different users. The choice of material is not a coincidence either. It is possible to manufacture dual colour products with this highly resistant, thermally stable organic compound, giving the collection a cheerful note. The result? Practical containers with covers, available in two sizes, a dispenser, a large glass and a toilet brush. Accessories that can be adapted to any type of lifestyle. No complications.

b-smart

Los complementos **b-smart** son perfectos para un baño práctico y funcional. Su diseño y su capacidad han sido pensados para dar respuesta a los diferentes usuarios. La elección del material tampoco es casual. Se trata de un compuesto orgánico termoestable de gran resistencia que permite fabricar productos bi-color, lo que da un toque divertido a la colección. El resultado son unos prácticos contenedores con tapa, disponibles en dos medidas, un dosificador, un vaso de grandes dimensiones y un escobillero. Unos complementos que se pueden adaptar a cualquier tipo de vida. Sin complicaciones.

Design by





B05102002
HOOK (2 PCS)
COLGADOR (2 U)
GLOSSY STAINLESS STEEL / INOX BRILLO



○
2,5x4,3x5,1 CM / INCH 1x1.7x2

B07035186
BRUSH-HOLDER
PORTACEPILLOS
WHITE / BLANCO



△
10,8x10,8x9,4 CM / INCH 4.3x4.3x3.7



B07004186
SOAP DISPENSER
DOSIFICADOR
WHITE / BLANCO



425 ML



10,8x8,6x14,4 CM / INCH 4.3x3.4x5.7

B07048186
CONTAINER WITH COVER
CONTAINER CON TAPA
WHITE / BLANCO



21,7x10,9x6,7 CM / INCH 8.5x4.3x2.6

B07049186
DOUBLE CONTAINER WITH COVER
CONTAINER DOBLE CON TAPA
WHITE / BLANCO



21,7x21,8x7,4 CM / INCH 8.5x8.6x2.9

B07001186
TOILET BRUSH
ESCOBILLERO
WHITE / BLANCO



10,9x10,9x38,4 CM / INCH 4.3x4.3x15.1

B030097
TOWEL RACK
TOALLERO
WHITE / BLANCO



45x5x4 CM / INCH 17.7x2x1.6



**THE PERFECT
ACCESSORIES FOR A
PRACTICAL, MODERN AND
SIMPLE BATHROOM**

COMPLEMENTOS PERFECTOS
PARA UN BAÑO PRÁCTICO,
MODERNO Y FUNCIONAL

B05102002
HOOK (2 PCS)
COLGADOR (2 U)
GLOSSY STAINLESS STEEL / INOX BRILLO



○
2,5x4,3x5,1 CM / INCH 1x1.7x2

B07035189
BRUSH-HOLDER
PORTACEPILLOS
WHITE - GREY / BLANCO - GRIS



△
10,8x10,8x9,4 CM / INCH 4.3x4.3x3.7

B07004189
SOAP DISPENSER
DOSIFICADOR
WHITE - GREY / BLANCO - GRIS



425 ML
△
10,8x8,6x14,4 CM / INCH 4.3x3.4x5.7

B07048189
CONTAINER WITH COVER
CONTAINER CON TAPA
WHITE - GREY / BLANCO - GRIS



△
21,7x10,9x6,7 CM / INCH 8.5x4.3x2.6

B07049189
DOUBLE CONTAINER WITH COVER
CONTAINER DOBLE CON TAPA
WHITE - GREY / BLANCO - GRIS



△
21,7x21,8x7,4 CM / INCH 8.5x8.6x2.9

B07001189
TOILET BRUSH
ESCOBILLERO
WHITE - GREY / BLANCO - GRIS



△
10,9x10,9x38,4 CM / INCH 4.3x4.3x15.1

B030099
TOWEL RACK
TOALLERO
GREY / GRIS

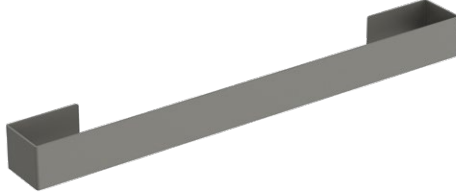

45x5x4 CM / INCH 17.7x2x1.6



**OUR CONTAINERS ARE
DESIGNED WITH THE IDEA OF
PROVIDING EACH MEMBER OF
THE FAMILY WITH THEIR OWN
SPACE FOR STORAGE**

CONTENEDORES PENSADOS
PARA QUE CADA MIEMBRO DE
LA FAMILIA TENGA SU PROPIO
ESPACIO DE ALMACENAJE



Container collection aids to maintain an arranged and harmonic aesthetic in the shower or bath area. Respecting Bath+ philosophy **Container** takes advantage of the space at maximum and release bath zones. This collection has been designed thinking in the use it is going to have. As a result, it obtains very functional grated containers, with different shapes and measures. They easily adapt to any life style.

container

Container es una colección que ayuda a mantener una estética ordenada y armónica dentro del espacio de la ducha o la bañera. Respetando la filosofía de Bath+, aprovecha al máximo el espacio y libera zonas del baño. Se ha diseñado pensando en el uso que se le va a dar, obteniendo como resultado contenedores muy funcionales, de diferentes formas y medidas, que se adaptan con facilidad a cualquier estilo de vida.





B06030001
SHOWER SOAP DISH
 JABONERA DE DUCHA
 CHROME / CROMO



○ ⊞
 20x10,5x3 CM / INCH 7.9x4.1x1.2

B06087001
RIGHT TWO-LEVEL SHOWER SOAP DISH
 JABONERA DE DUCHA ESCALÓN DERECHO
 CHROME / CROMO



○ ⊞
 30x12,5x6 CM / INCH 11.8x4.9x2.4

B06033001
SHOWER SOAP DISH
 JABONERA DE DUCHA
 CHROME / CROMO



○ ⊞
 30x12,5x4,5 CM / INCH 11.8x4.9x1.8

B06088001
LEFT TWO-LEVEL SHOWER SOAP DISH
 JABONERA DE DUCHA ESCALÓN IZQUIERDO
 CHROME / CROMO



○ ⊞
 30x12,5x6 CM / INCH 11.8x4.9x2.4

B06048001
SHOWER SOAP DISH
 JABONERA DE DUCHA
 CHROME / CROMO



○ ⊞
 40x12,5x4 CM / INCH 15.7x4.9x1.6

B06049001
SHOWER SOAP DISH
JABONERA DE DUCHA
CHROME / CROMO



30x12,5x11 CM / INCH 11.8x4.9x4.3

B06050001
CORNER SHOWER SOAP DISH
JABONERA DE DUCHA RINCÓN
CHROME / CROMO



20x20x6 CM / INCH 7.9x7.9x2.4

B06089001
CORNER SHOWER SOAP DISH
JABONERA DE DUCHA RINCÓN
CHROME / CROMO



25x25x6 CM / INCH 9.8x9.8x2.4

B06032001
CORNER SHOWER SOAP DISH
JABONERA DE DUCHA RINCÓN
CHROME / CROMO



25x25x11 CM / INCH 9.8x9.8x4.3



Diabolo is a fresh and fun proposal, born from the ingenious combination of just two pieces and a rope. The new Bath+ collection takes its inspiration from ship moorings and moves away from more traditional bathroom proposals.

A towel bar, a toilet paper holder and a hook are the pieces that make up the range, which can combine two colours based on various possibilities: white, black or red for the rope and white, black or chrome for the pieces. **Diabolo**, with its dual system, is easy to install: it can be attached to the wall with 3M adhesive tape or secured with conventional screws. In both cases, the attachment fixing is completely secure.

diabolo

Diabolo es una propuesta fresca y divertida, que nace de la ingeniosa combinación de tan sólo dos piezas y una cuerda. La nueva colección de Bath+ se inspira en los amarres de barco y se aleja de las propuestas de baño más tradicionales.

Un toallero, un portarrollos y un colgador son las piezas que componen la gama, que pueden asociar dos colores a partir de varias posibilidades: blanco, negro o rojo para la cuerda y blanco, negro o cromo para las piezas. **Diabolo** es fácil de instalar con su sistema dual: o se engancha en la pared con la cinta adhesiva 3M o se puede sujetar con los tornillos habituales. En ambos casos, la fijación está totalmente garantizada.

Design by





**EASY INSTALLATION
WITHOUT DRILLING**

FÁCIL INSTALACIÓN
SIN TALADRO



3M
**BONDED WITH
HIGH ADHESION
ADHESIVE (3M)**

FIJACIÓN CON
ADHESIVO DE ALTA
ADHERENCIA (3M)



**STATIC LOAD
RESISTANCE
OF 5 KG**

RESISTENCIA
DE UNA CARGA
ESTÁTICA DE 5 KG



**PRODUCT
WITH A 10 YEAR
WARRANTY**

PRODUCTO
CON 10 AÑOS
DE GARANTÍA



**DO NOT USE ON
PAINTED SURFACES
AND GYPSUM WALLS**

NO USAR EN SUPERFICIES
PINTADAS NI EN
PAREDES RUGOSAS



YANG RIPOL

PRODUCT DESIGNER **BATH+**

It flees from the idea of traditional bath accessories. Who is it aimed at?

diabolo es una propuesta muy original. Huye de la idea de los accesorios de baño tradicionales. ¿A quién va dirigida?

Our philosophy is to create objects that are iconic and different, but always giving priority to functionality. Diabolo is designed for people who are a bit nonconformist, who seek unique products, but without ornamentation and very functional.

Nuestra filosofía es crear objetos icónicos, diferentes, pero siempre primando la funcionalidad. Diabolo está pensada para gente algo inconformista que busca productos únicos, pero sin ornamentos, muy funcionales.

1 How is it possible that a collection can be born based on just two pieces?

¿Cómo puede ser que a partir de solo dos piezas pueda nacer una colección?

The concept is very simple, it is inspired by ship moorings and has a geometric and essential aesthetic. The mechanical principle and visual style can be easily applied to several different functions.

El concepto es muy simple, se inspira en los amarres de barco, tiene una estética geométrica y esencial. Ese principio mecánico y estilo visual pueden aplicarse sencillamente a varias funciones distintas.

3 How can a functional collection be created from an initial concept that is, in principle, very simple?

¿Cómo de un concepto inicial, en principio simple, se puede crear una colección funcional?

I believe that at times the simpler the idea, the more flexible its application.

Creo que a veces cuanto más sencilla es la idea, más flexible resulta su aplicación.

2 **diabolo** is a very original proposal.

4 ¿How is the collection installed?

¿Cómo se instala la colección?

It is a dual collection. It can be installed by traditional screws or using 3M high adhesion adhesive, which allows quick and clean installation.

Es una colección dual. Se puede instalar mediante tornillería tradicional o utilizando un adhesivo de alta adherencia de 3M, lo cual permite una instalación rápida y limpia.

5 What is more important, the design or the ability to personalize lengths of space?

¿Qué es más importante, su diseño o su capacidad de personalizar las longitudes del espacio?

Bathroom products are usually rigid, we are intrigued by the idea of a flexible product that can be tied without a fixed position, as if it were a clothing accessory. This allows a very different style, customization in both its daily use and its installation.

Los productos para baño normalmente son rígidos, nos intriga la idea de un producto flexible que se puede atar sin una posición fija, como si fuera casi un accesorio de ropa. Eso permite un estilo muy diferente, y una personalización tanto en su uso diario como en su instalación.

6 In what kinds of bathrooms do you picture diabolo?

¿En qué tipo de cuartos de baño te imaginas **diabolo**?

We see it possibly for small bathrooms, with essential contemporary-style products.

Lo imaginamos en cuartos de baño posiblemente de dimensiones reducidas, con productos esenciales de estilo contemporáneo.







**PERSONALIZE YOUR
BATHROOM WITH PROPOSALS
THAT MOVE AWAY FROM THE
TRADITIONAL SOLUTIONS**

PERSONALIZA TU BAÑO CON
PROPUESTAS QUE SE ALEJAN DE
LO TRADICIONAL

275 16 64
TOWEL RACK (INCH 8-16)
TOALLERO (20-40 CM)
CHROME - BLACK / CROMO - NEGRO

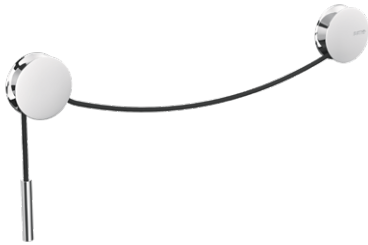

Ø 5x1,7 CM / INCH Ø 2x0.7

275 16 58
PAPER HOLDER WITHOUT COVER
PORTAPAPEL SIN TAPA
CHROME - BLACK / CROMO - NEGRO



Ø 5x1,7 CM / INCH Ø 2x0.7

275 15 64
TOWEL RACK (INCH 8-16)
TOALLERO (20-40 CM)
CHROME - WHITE / CROMO - BLANCO





Ø 5x1,7 CM / INCH Ø 2x0.7

275 15 58
PAPER HOLDER WITHOUT COVER
PORTAPAPEL SIN TAPA
CHROME - WHITE / CROMO - BLANCO

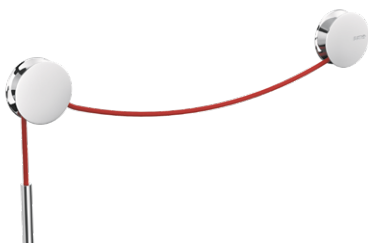

Ø 5x1,7 CM / INCH Ø 2x0.7

275 14 64
TOWEL RACK (INCH 8-16)
TOALLERO (20-40 CM)
CHROME - RED / CROMO - ROJO



Ø 5x1,7 CM / INCH Ø 2x0.7

275 14 58
PAPER HOLDER WITHOUT COVER
PORTAPAPEL SIN TAPA
CHROME - RED / CROMO - ROJO



Ø 5x1,7 CM / INCH Ø 2x0.7



275 01 21
HOOK
COLGADOR
CHROME / CROMO



©
Ø 5x3,8 CM / INCH Ø 2x1.5

**BE BRAVE AND ADD A
SPLASH OF COLOUR TO YOUR
BATHROOM WITH A MORE
DARING COMBINATION**

ARRIÉSGATE Y DALE UN TOQUE
DE COLOR A TU CUARTO DE
BAÑO CON UNA COMBINACIÓN
MÁS ATREVIDA

**TAKE A CHANCE ON A
COLLECTION INSPIRED
BY SHIP MOORINGS**

ATRÉVETE CON UNA
COLECCIÓN INSPIRADA EN
LOS AMARRES DE BARCO

275 65 21

HOOK

COLGADOR

MATTE WHITE / BLANCO MATE



Ø 5x3,8 CM / INCH Ø 2x1.5



275 56 64

TOWEL RACK (INCH 8-16)
TOALLERO (20-40 CM)

MATTE WHITE - BLACK / BLANCO MATE - NEGRO

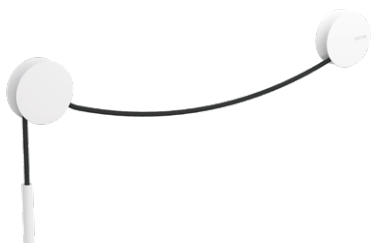

Ø 5x1,7 CM / INCH Ø 2x0.7

275 56 58

PAPER HOLDER WITHOUT COVER
PORTAPAPEL SIN TAPA

MATTE WHITE - BLACK / BLANCO MATE - NEGRO



Ø 5x1,7 CM / INCH Ø 2x0.7

275 55 64

TOWEL RACK (INCH 8-16)
TOALLERO (20-40 CM)

MATTE WHITE - WHITE / BLANCO MATE - BLANCO



Ø 5x1,7 CM / INCH Ø 2x0.7

275 55 58

PAPER HOLDER WITHOUT COVER
PORTAPAPEL SIN TAPA

MATTE WHITE - WHITE / BLANCO MATE - BLANCO



Ø 5x1,7 CM / INCH Ø 2x0.7

275 54 64

TOWEL RACK (INCH 8-16)
TOALLERO (20-40 CM)

MATTE WHITE - RED / BLANCO MATE - ROJO

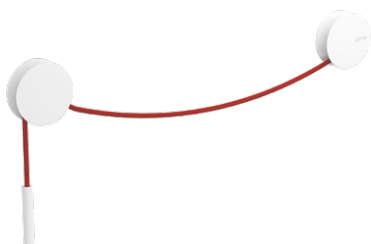

Ø 5x1,7 CM / INCH Ø 2x0.7

275 54 58

PAPER HOLDER WITHOUT COVER
PORTAPAPEL SIN TAPA

MATTE WHITE - RED / BLANCO MATE - ROJO



Ø 5x1,7 CM / INCH Ø 2x0.7

275 66 64
TOWEL RACK (INCH 8-16)
TOALLERO (20-40 CM)
MATTE BLACK - BLACK / NEGRO MATE - NEGRO

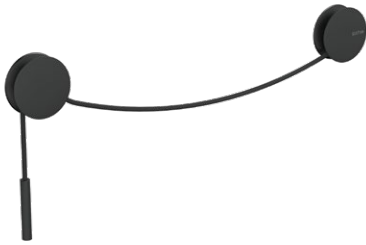

☉ ◻
Ø 5x1,7 CM / INCH Ø 2x0.7

275 66 58
PAPER HOLDER WITHOUT COVER
PORTAPAPEL SIN TAPA
MATTE BLACK - BLACK / NEGRO MATE - NEGRO



☉ ◻
Ø 5x1,7 CM / INCH Ø 2x0.7

275 65 64
TOWEL RACK (INCH 8-16)
TOALLERO (20-40 CM)
MATTE BLACK - WHITE / NEGRO MATE - BLANCO



☉ ◻
Ø 5x1,7 CM / INCH Ø 2x0.7

275 65 58
PAPER HOLDER WITHOUT COVER
PORTAPAPEL SIN TAPA
MATTE BLACK - WHITE / NEGRO MATE - BLANCO



☉ ◻
Ø 5x1,7 CM / INCH Ø 2x0.7

275 64 64
TOWEL RACK (INCH 8-16)
TOALLERO (20-40 CM)
MATTE BLACK - RED / NEGRO MATE - ROJO

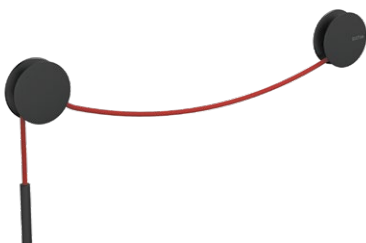

☉ ◻
Ø 5x1,7 CM / INCH Ø 2x0.7

275 64 58
PAPER HOLDER WITHOUT COVER
PORTAPAPEL SIN TAPA
MATTE BLACK - RED / NEGRO MATE - ROJO



☉ ◻
Ø 5x1,7 CM / INCH Ø 2x0.7

**GO FOR CONTRAST AND USE
BLACK ACCESSORIES THAT
WILL STAND OUT AGAINST
WHITE WALLS**

APUESTA POR EL CONTRASTE
Y PON ACCESORIOS NEGROS
QUE DESTAQUEN SOBRE LAS
PAREDES BLANCAS

275 36 21

HOOK
COLGADOR
MATTE BLACK / NEGRO MATE



Ø 5x3,8 CM / INCH Ø 2x1,5



duo round



duo square



duo is a collection of adhesive bathroom accessories which can be installed without any need to drill or make holes in the wall. Designed to make maximum use of the walls and free up areas of the bathroom, they are not only ideal for small spaces but also for areas which need to be well-ordered.

With a very functional design, all of the **duo** pieces can be purchased with round trims in the more traditional line, and square trims for more modern environments.

They are highly resistant adhesive pieces which are easy to install for people who want to avoid complications when updating their bathrooms.

duo

duo es una colección de accesorios de baño adhesivos que se instalan sin necesidad de taladrar ni hacer agujeros en la pared. Pensada para aprovechar al máximo las paredes y liberar zonas del baño, es ideal para espacios reducidos pero también para aquellos que necesitan estar ordenados.

Con un diseño muy funcional, todas las piezas **duo** se pueden encontrar con embellecedores redondos, de línea más clásica, y cuadrados, para ambientes más modernos.

Son piezas adhesivas de gran resistencia y fácil instalación para los que no quieren complicaciones a la hora de actualizar el espacio del baño.

Design by





**EASY INSTALLATION
WITHOUT DRILLING**

FÁCIL INSTALACIÓN
SIN TALADRO



**BONDED WITH
HIGH ADHESION
ADHESIVE**

FIJACIÓN CON
ADHESIVO DE ALTA
ADHERENCIA



**STATIC LOAD
RESISTANCE
OF 5 KG**

RESISTENCIA
DE UNA CARGA
ESTÁTICA DE 5 KG



**PRODUCT
WITH A 10 YEAR
WARRANTY**

PRODUCTO
CON 10 AÑOS
DE GARANTÍA



**DO NOT USE ON
PAINTED SURFACES
AND GYPSUM WALLS**

NO USAR EN SUPERFICIES
PINTADAS NI EN
PAREDES RUGOSAS



RAUL RUIZ

PRODUCT DESIGNER BATH+

1 What is duo? ¿Qué es duo?

Duo is the first collection of bathroom accessories from Bath+ which are installed without any need to drill or make holes. Nowadays, people move house many times, many decide to renovate or update their rooms or simply to give the rooms some order to make them more functional. These new necessities require products on the market which are easy to install, without complications, and affordable for all budgets. We decided that there was a real need for which we could produce a design as a differential value. With Duo we have managed to create a collection of adhesive accessories which are suitably functional and which, unlike others on the market, have as meticulous a design as you would find in any other collection which requires drilling.

Duo es la primera colección de accesorios de baño de Bath+ que se instala sin necesidad de taladrar ni hacer agujeros. Hoy las personas cambian su lugar de vivienda en numerosas ocasiones, muchas deciden renovar o actualizar sus espacios o simplemente ordenar las estancias para que resulten más funcionales. Estas nuevas necesidades requieren de productos en el mercado que sean fáciles de instalar, sin complicaciones, y asequibles a todos los bolsillos. Hemos pensado que había una necesidad real a la que además podíamos aportar el diseño como valor diferencial. Con Duo se ha conseguido crear una colección de accesorios adhesivos que cumple con su funcionalidad y, a diferencia de otras en el mercado, tiene un diseño cuidado como cualquier otra colección de accesorios que requiere taladrar.

2 How are duo accessories installed? ¿Cómo se instalan los accesorios duo?

All of the pieces in the collection (hangers, soap dishes, dispensers, glasses, towel rails, toilet roll holders, toilet brushes and containers) can be easily, comfortably and cleanly adhered so that anyone can install them.

Todas las piezas de la colección (colgadores, jaboneras, dosificadores, vasos, toalleros, portapapeles, escobilleros y containers) se pegan de una forma muy sencilla, cómoda y limpia para que cualquier persona lo pueda colocar.

3 Are the adhesive accessories resistant? ¿Los accesorios adhesivos son resistentes?

The Duo accessories have undergone strict validation tests which have been carried out in our quality laboratory, exceeding a static load of above 5kg. The use of Quick-Fix adhesives in our accessories enables us to offer the very highest guarantee of bonding, to ensure resistance to moisture and high temperatures as well as cleaning products and solvents.

Los accesorios Duo se han sometido a las estrictas pruebas de validación realizadas en nuestro laboratorio de calidad superando una carga estática de más de 5kg. El uso de adhesivo Quick-Fix en nuestros accesorios nos permite ofrecer la máxima garantía de fijación, asegurar su resistencia a la humedad y altas temperaturas, así como a los productos de limpieza y disolventes.

4 What does the duo collection offer a bathroom?

¿Qué aporta la colección duo a un baño?

This adhesive collection has been designed to make maximum use of walls and free up areas of the bathroom. It is ideal for small spaces, but also for areas which need to be well-ordered. With this adhesion system we can install as many accessories as we want, in the place we like best: on the wall, behind a door or partition or on the side of a cabinet. All of the pieces can be purchased with round trims in the more traditional line, and square trims for more modern environments.

Esta colección adhesiva ha sido pensada para aprovechar al máximo las paredes y liberar zonas del baño. Es ideal para espacios reducidos pero también para aquellos que necesitan estar ordenados. Con este sistema de adhesivo, podemos colocar tantos accesorios como queramos, en el lugar que más nos guste: en la pared, detrás de una puerta, una mampara o en el lateral de un armario. Todas las piezas se pueden encontrar con embellecedores redondos, de línea más clásica, y cuadrados, para ambientes más modernos.

5 Who are your target customers?

¿A qué público va dirigido?

Duo has very diverse customers because the pieces are general-purpose; from people who move a lot to large families, young people, single people, the elderly...in short, everyone who wants functional designs which are easy to install and affordable.

Duo tiene un público muy diverso porque las piezas son universales, desde personas nómadas, familias numerosas, jóvenes, singles, gente mayor... En definitiva, todos los que quieren diseños funcionales, fáciles de instalar y asequibles.



duo round



262 01 21
HOOK
COLGADOR
CHROME / CROMO



5,5x5x5,5 CM / INCH 2.2x2x2.2

262 01 32
SOAP DISH
JABONERA
CHROME / CROMO



11x13x5,5 CM / INCH 4.3x5.1x2.2

262 01 52
BRUSH-HOLDER
PORTACEPILLOS
CHROME / CROMO



7,5x11x12 CM / INCH 2.9x4.3x4.7



262 01 05
SOAP DISPENSER
DOSIFICADOR
CHROME / CROMO



200 ML
7,5x12x16 CM / INCH 2.9x4.7x6.3

262 01 04
SOAP DISPENSER
DOSIFICADOR
CHROME / CROMO



240 ML
6x10x18,5 CM / INCH 2.4x3.9x7.3



262 01 49
SHOWER SOAP DISH
JABONERA DE DUCHA
CHROME / CROMO



15x11x5,5 CM / INCH 5.9x4.3x2.2

262 01 30
SHOWER SOAP DISH
JABONERA DE DUCHA
CHROME / CROMO



20x11x5,5 CM / INCH 7.9x4.3x2.2

262 01 33
SHOWER SOAP DISH
JABONERA DE DUCHA
CHROME / CROMO





30x13x7 CM / INCH 11.8x5.1x2.7

262 01 88
LEFT TWO-LEVEL SHOWER SOAP DISH
JABONERA DE DUCHA ESCALÓN IZQUIERDO
CHROME / CROMO



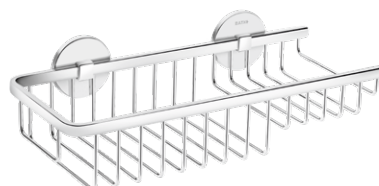

30x13x8 CM / INCH 11.8x5.1x3.1

262 01 87
RIGHT TWO-LEVEL SHOWER SOAP DISH
JABONERA DE DUCHA ESCALÓN DERECHO
CHROME / CROMO

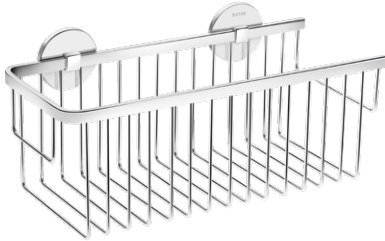

30x13x8 CM / INCH 11.8x5.1x3.1

262 01 42
SHOWER SOAP DISH
 JABONERA DE DUCHA
 CHROME / CROMO



30x13x13 CM / INCH 11.8x5.1x5.1

262 01 50
CORNER SHOWER SOAP DISH
 JABONERA DE DUCHA RINCÓN
 CHROME / CROMO



21x21x8 CM / INCH 8.3x8.3x3.1

262 01 48
SHOWER SOAP DISH
 JABONERA DE DUCHA
 CHROME / CROMO



40x13x6 CM / INCH 15.7x5.1x2.4

262 01 89
CORNER SHOWER SOAP DISH
 JABONERA DE DUCHA RINCÓN
 CHROME / CROMO

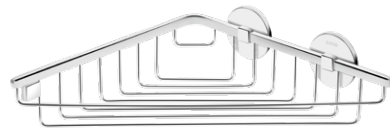

26x26x8 CM / INCH 10.2x10.2x3.1



262 01 41
CORNER SHOWER SOAP DISH
 JABONERA DE DUCHA RINCÓN
 CHROME / CROMO

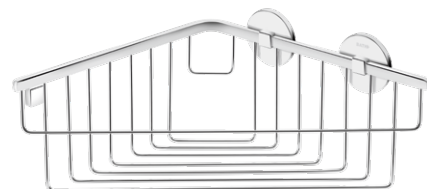

26x26x13 CM / INCH 10.2x10.2x5.1

262 01 72
TOWEL RING
TOALLERO ARO
CHROME / CROMO



○ ◻
20x5x22 CM / INCH 7.8x2x8.7

262 01 63
TOWEL RACK
TOALLERO
CHROME / CROMO



○ ◻
30,5x7x5,5 CM / INCH 12x2.7x2.2

262 01 64
TOWEL RACK
TOALLERO
CHROME / CROMO



○ ◻
45,5x7x5,5 CM / INCH 17.9x2.7x2.2

262 01 65
TOWEL RACK
TOALLERO
CHROME / CROMO



○ ◻
60,5x7x5,5 CM / INCH 23.8x2.7x2.2



262 01 44
GLASS SHELF
ESTANTE VIDRIO
CHROME / CROMO



◆ ⊕
40x10,5x5,5 CM / INCH 15.7x4.1x2

262 01 45
GLASS SHELF
ESTANTE VIDRIO
CHROME / CROMO



◆ ⊕
60x10,5x5,5 CM / INCH 23.6x4.1x2

262 01 68
TOWEL RACK SHELF
TOALLERO ESTANTE
CHROME / CROMO

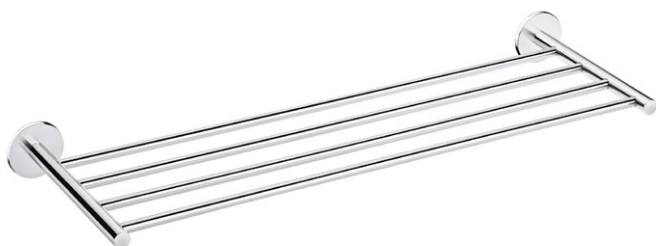

⊙ ⊕
61x20x5,5 CM / INCH 24x7.9x2.2



**MAKE BETTER USE OF
YOUR SPACE; PUT AN
ACCESSORY WHEREVER
YOU NEED IT**

APROVECHA MEJOR TU
ESPACIO, COLOCA UN
ACCESORIO ALLÍ DONDE
LO NECESITES

262 01 56
RIGHT PAPER HOLDER WITHOUT COVER
PORTAPAPEL SIN TAPA DERECHO
CHROME / CROMO



○
17x7,5x5,5 CM / INCH 6.7x2.9x2.2

262 01 57
LEFT PAPER HOLDER WITHOUT COVER
PORTAPAPEL SIN TAPA IZQUIERDO
CHROME / CROMO



○
17x7,5x5,5 CM / INCH 6.7x2.9x2.2



262 01 59
PAPER HOLDER WITH COVER
PORTAPAPEL CON TAPA
CHROME / CROMO



○
12,5x5x13 CM / INCH 4.9x2x5.1



262 01 00
TOILET BRUSH
ESCOBILLERO
CHROME / CROMO



○ ⊕ ◆
7,5x11x38 CM / INCH 2.9x3.9x15

**FORGET ABOUT
DRILLING
WALLS; GET
THE MOST OUT
OF THEM**

OLVÍDATE
DE AGUJEREAR
LAS PAREDES,
SÁCALES
EL MÁXIMO
PARTIDO

262 01 01
TOILET BRUSH
ESCOBILLERO
CHROME / CROMO



○ ⊕
9x11x41,5 CM / INCH 3.5x4.3x16.3

duo square



264 01 21
HOOK
COLGADOR
CHROME / CROMO



5x5x5 CM / INCH 2x2x2

264 01 32
SOAP DISH
JABONERA
CHROME / CROMO



11x13x5 CM / INCH 4.3x5.1x2

264 01 52
BRUSH-HOLDER
PORTACEPILLOS
CHROME / CROMO



7,5x11x12 CM / INCH 2.9x4.3x4.7

264 01 05
SOAP DISPENSER
DOSIFICADOR
CHROME / CROMO



200 ML

7,5x12x16 CM / INCH 2.9x4.7x6.3

264 01 04
SOAP DISPENSER
DOSIFICADOR
CHROME / CROMO



240 ML

6x10x18,5 CM / INCH 2.4x4x7.3



264 01 49
SHOWER SOAP DISH
JABONERA DE DUCHA
CHROME / CROMO



15x11x5 CM / INCH 5.9x4.3x2

264 01 30
SHOWER SOAP DISH
JABONERA DE DUCHA
CHROME / CROMO



20x11x5,5 CM / INCH 7.9x4.3x2.2

264 01 33
SHOWER SOAP DISH
JABONERA DE DUCHA
CHROME / CROMO



30x13x7 CM / INCH 11.8x5.1x2.8

264 01 48
SHOWER SOAP DISH
JABONERA DE DUCHA
CHROME / CROMO



40x13x6 CM / INCH 15.7x5.1x2.4

264 01 88
LEFT TWO-LEVEL SHOWER SOAP DISH
JABONERA DE DUCHA ESCALÓN IZQUIERDO
CHROME / CROMO

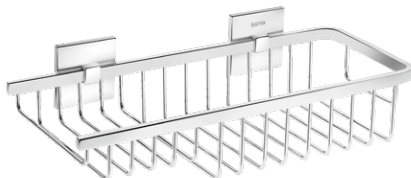

30x13x8 CM / INCH 11.8x5.1x3.1

264 01 87
RIGHT TWO-LEVEL SHOWER SOAP DISH
JABONERA DE DUCHA ESCALÓN DERECHO
CHROME / CROMO

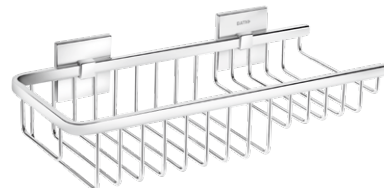

30x13x8 CM / INCH 11.8x5.1x3.1

264 01 42
SHOWER SOAP DISH
 JABONERA DE DUCHA
 CHROME / CROMO

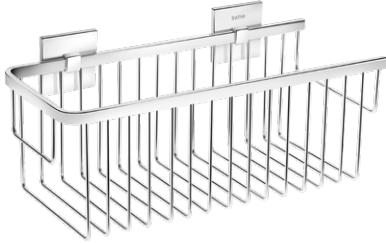

30x13x13 CM / INCH 11.8x5.1x5.1

264 01 50
CORNER SHOWER SOAP DISH
 JABONERA DE DUCHA RINCÓN
 CHROME / CROMO



21x21x8 CM / INCH 8.3x8.3x3.1



264 01 89
CORNER SHOWER SOAP DISH
 JABONERA DE DUCHA RINCÓN
 CHROME / CROMO

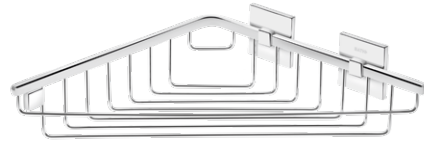

26x26x8 CM / INCH 10.2x10.2x3.1

264 01 41
CORNER SHOWER SOAP DISH
 JABONERA DE DUCHA RINCÓN
 CHROME / CROMO

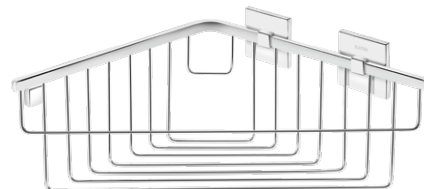

26x26x13 CM / INCH 10.2x10.2x5.1

264 01 72
TOWEL RING
TOALLERO ARO
CHROME / CROMO



○○
20x5x22 CM / INCH 7.9x2x8.7

264 01 63
TOWEL RACK
TOALLERO
CHROME / CROMO



○○
30,5x7x5 CM / INCH 12x2.7x2

264 01 64
TOWEL RACK
TOALLERO
CHROME / CROMO



○○
45,5x7x5 CM / INCH 17.9x2.7x2

264 01 65
TOWEL RACK
TOALLERO
CHROME / CROMO



○○
60,5x7x5 CM / INCH 23.8x2.7x2



264 01 44
GLASS SHELF
ESTANTE VIDRIO
CHROME / CROMO



◆ ⊕
40x10,5x5,5 CM / INCH 15.7x4.1x2

264 01 45
GLASS SHELF
ESTANTE VIDRIO
CHROME / CROMO



◆ ⊕
60x10,5x5,5 CM / INCH 23.6x4.1x2

264 01 68
TOWEL RACK SHELF
TOALLERO ESTANTE
CHROME / CROMO

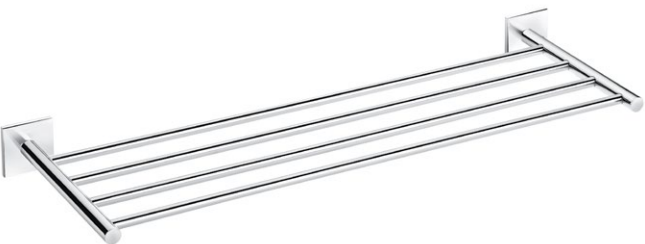

⊙ ⊙
60,5x19,5x5 CM / INCH 23.8x7.7x2



**DO NOT
SACRIFICE YOUR
NEEDS, OPT FOR
FUNCTIONALITY**

NO RENUNCIAS A
TUS NECESIDADES,
APUESTA POR LA
FUNCIONALIDAD

264 01 56
RIGHT PAPER HOLDER WITHOUT COVER
PORTAPAPEL SIN TAPA DERECHO
CHROME / CROMO



○
17x7,5x5 CM / INCH 6.7x2.9x2

264 01 57
LEFT PAPER HOLDER WITHOUT COVER
PORTAPAPEL SIN TAPA IZQUIERDO
CHROME / CROMO



○
17x7,5x5 CM / INCH 6.7x2.9x2



264 01 59
PAPER HOLDER WITH COVER
PORTAPAPEL CON TAPA
CHROME / CROMO



○
12,5x5x13 CM / INCH 4.9x2x5.1

264 01 00
TOILET BRUSH
ESCOBILLERO
CHROME / CROMO



○ ⊕ ◆
7,5x11x38 CM / INCH 2.9x4.3x14.7

264 01 01
TOILET BRUSH
ESCOBILLERO
CHROME / CROMO



○ ○
9x11x41,5 CM / INCH 3.5x4.3x16.3



**COMBINE AS MANY
ACCESSORIES AS YOU
WANT, MAKE YOUR LIFE
MORE COMFORTABLE**

COMBINA TANTOS
ACCESORIOS COMO
QUIERAS, HAZ TU VIDA
MÁS CÓMODA

line is an essential idea, a simple ribbon, a taut gesture that swivels and becomes a functional object. An idea that has been maintained until achieving a collection of accessories designed for today's bathroom.

The new Bath+ collection offers a modern aesthetic, a versatile proposal that fits in well with neutral decor, as well as more informal environments.

Line is an option that seeks convenient installation. It can be attached by means of conventional screws or Quick-Fix adhesive tape. Both options are effective.

line

line es una idea esencial, una simple cinta, un gesto tenso que gira y se convierte en un objeto funcional. Una idea que se mantiene hasta lograr una colección de accesorios y complementos pensada para un baño actual.

La nueva colección de Bath+ ofrece una estética moderna, una propuesta muy versátil que tanto puede encajar en decoraciones neutras, como en ambientes más informales.

Line es una opción que busca la comodidad en su instalación. Se puede sujetar mediante tornillería tradicional o a través de cinta adhesiva Quick-Fix. Las dos opciones son efectivas.

Design by





**EASY INSTALLATION
WITHOUT DRILLING**

FÁCIL INSTALACIÓN
SIN TALADRO



**BONDED WITH
HIGH ADHESION
ADHESIVE**

FIJACIÓN CON
ADHESIVO DE ALTA
ADHERENCIA



**STATIC LOAD
RESISTANCE
OF 5 KG**

RESISTENCIA
DE UNA CARGA
ESTÁTICA DE 5 KG



**PRODUCT
WITH A 10 YEAR
WARRANTY**

PRODUCTO
CON 10 AÑOS
DE GARANTÍA



**DO NOT USE ON
PAINTED SURFACES
AND GYPSUM WALLS**

NO USAR EN SUPERFICIES
PINTADAS NI EN
PAREDES RUGOSAS



RICARD FERRER

PRODUCT DESIGNER BATH+

1 What is the line concept based on?

¿De qué concepto parte line?

It is easy to explain Line, in fact its formal resolution communicates the concept accurately. Line is an essential idea, a simple ribbon, a taut gesture that swivels and becomes a functional object. The challenge throughout the collection has been to keep the idea clean up to the final product, without adding elements that distract and compete with the main concept.

Explicar Line es fácil, de hecho, su resolución formal comunica de forma precisa el concepto. Line es una idea esencial, una simple cinta, un gesto tenso que gira y se convierte en un objeto funcional. El reto en toda la colección ha sido mantener la idea limpia hasta el producto final, sin añadir elementos que distraigan y compitan con el concepto principal.

2 Some pieces combine chrome finish with black plastic.

What effect do you want to achieve?

Algunas piezas combinan el acabado cromado con el plástico negro. ¿Qué efecto se quiere conseguir?

The relationship between plastic and metal is not only an aesthetic decision, fortunately plastic is now accepted in the materials sector codes, although commercially there are still some reservations and an effort is made to hide it, minimizing its presence.

We think it is necessary to move the debate on the perception of materials with respect to the product positioning codes. Plastic today does not mean a low-cost product, for us it synonymous with intelligence because we can integrate diverse solutions in a single component. In the case of the Line collection, it provides an accurate sense of a fit between components, a precise relationship between metal and plastic that conveys a high perception of quality, that is the trick, to know how to bring out the best of each material and manage its codes.

La relación entre el plástico y el metal no es una decisión únicamente estética, afortunadamente el plástico se admite ya en los códigos de materiales del sector, comercialmente todavía hay algunas reservas y se busca esconderlo, minimizar su presencia.

Pensamos que es necesario desplazar el debate de la percepción de los materiales respecto a los códigos de posicionamiento de un producto, decir plástico hoy no es sinónimo de producto de bajo coste, para nosotros utilizarlo es sinónimo de inteligencia porque podemos en un único componente integrar diversas soluciones, en el caso de la colección Line nos aporta un sentido de ajuste entre componentes, una relación precisa, entre el metal y el plástico que transmite una percepción de calidad alta, ese es el truco, saber sacar lo mejor de cada material y gestionar sus códigos.

3 How are the accessories installed?

¿Cómo se instalan los accesorios?

Line can be installed with traditional screws or an adhesive bond that allows a clean and effective installation.

Line puede instalarse mediante tornillería tradicional o mediante una unión adhesiva que permite una instalación limpia y efectiva.

4 Who is line intended for?

¿A qué público se dirige line?

Line is voluntarily neutral, it has not been designed for a specific target group, we assume it fits better in more casual environments, due to the quickness of its resolution, but at the same time the technical aspect, the formal rigour, fits in perfectly with a more classic and timeless profile. We look forward to seeing what our customers do with the product, to see how they integrate it and how it engages with the rest of the furniture.

Line es voluntariamente neutra, no ha sido pensada para un público específico, suponemos que encaja mejor en ambientes más desenfadados por la inmediatez en su resolución, pero a su vez el aspecto técnico, el rigor formal encaja perfectamente con un perfil más clásico y atemporal. Tenemos ganas de ver lo que hacen nuestros clientes con el producto, ver como lo integran y como dialoga con el resto del equipamiento.

5 What sets it apart from the rest of the solutions on the market?

¿En qué se diferencia del resto de soluciones del mercado?

In Line, there is a good balance between quality, design and price that we hope the end user will appreciate. All of the pieces in the collection are well-balanced and have been designed to offer a complete essential range. At times, an accessory can be a genuine Meccano of pieces, supports, tubes, screws..., in Line we have abandoned that idea, everything is more immediate and honest.

En Line hay un balance muy bueno entre calidades, diseño y precio que confiamos que el usuario final valore, todas las piezas de la colección están muy equilibradas, han sido pensadas para ofrecer una gama esencial completa, a veces un accesorio puede ser un verdadero mecano de piezas, soportes, tubos, tornillos..., en line hemos abandonado esa idea, todo es más inmediato y honesto.





269 01 21
HOOK
COLGADOR
CHROME / CROMO



○△
3x2,9x11 CM / INCH 1.2x1.1x4.3



269 01 53
FREE STANDING BRUSH-HOLDER
PORTACEPILLOS ENCIMERA
CHROME / CROMO



○△
6,3x6,3x13,7 CM / INCH 2.5x2.5x5.4

269 01 04
FREE STANDING SOAP-DISH
DOSIFICADOR ENCIMERA
CHROME / CROMO



370 ML
○△
6,3x8,2x16 CM / INCH 2.5x3.2x6.3

**A TOWEL BAR CAN
EASILY BE INSTALLED
ON A CABINET SIDE
THANKS TO THE QUICK-
FIX ADHESIVE TAPE**

INSTALA FÁCILMENTE UN
TOALLERO EN EL LATERAL
DEL MUEBLE GRACIAS A LA
CINTA ADHESIVA QUICK-FIX

269 01 50
CORNER SHOWER SOAP DISH
JABONERA DE DUCHA RINCÓN
CHROME / CROMO

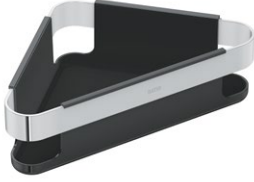

21,7x21,9x8 CM / INCH 8.5x8.6x3.1

Can be easily taken apart for cleaning. Extractable soap dish.
Fácil extracción para su limpieza. Jabonera extraíble.

269 01 49
SHOWER SOAP DISH
JABONERA DE DUCHA
CHROME / CROMO



30x10,6x8 CM / INCH 11.8x4.17x3.1

Can be easily taken apart for cleaning. Extractable soap dish.
Fácil extracción para su limpieza. Jabonera extraíble.



269 01 71
TOWEL RING
TOALLERO ARO
CHROME / CROMO



○△
3x12x12 CM / INCH 1.1x4.7x4.7

269 01 64
TOWEL RACK
TOALLERO
CHROME / CROMO



○△
40x6.5x3 CM / INCH 15.7x2.5x1.1

269 01 65
TOWEL RACK
TOALLERO
CHROME / CROMO



○△
60x6.5x3 CM / INCH 23.6x2.5x1.1



**THE COMBINATION OF
CHROME AND BLACK GIVES
A MODERN TOUCH TO SOME
OF THE COLLECTION'S PIECES**

LA COMBINACIÓN DEL
CROMADO Y EL NEGRO DA UN
TOQUE MODERNO A ALGUNAS
PIEZAS DE LA COLECCIÓN

269 01 68
TOWEL RACK SHELF
TOALLERO ESTANTE
CHROME / CROMO



○△
50x21,4x8,5 CM / INCH 19.7x8.4x3.4



269 01 58
PAPER HOLDER WITHOUT COVER
PORTAPAPEL SIN TAPA
CHROME / CROMO



○△
15,2x6,4x3 CM / INCH 6x2.5x1.2

269 01 59
PAPER HOLDER WITH COVER
PORTAPAPEL CON TAPA
CHROME / CROMO



○△
15,2x11x8 CM / INCH 6x4.3x3.2

SQUARE DESIGN FREE-STANDING ACCESSORIES SMOOTH OUT THEIR LINES WITH ROUNDED ANGLES

ACCESORIOS DE SUELO DE DISEÑO CUADRADO QUE SUAVIZAN SUS LÍNEAS CON ÁNGULOS REDONDEADOS

269 01 00
FREE STANDING TOILET BRUSH
ESCOBILLERO SUELO
CHROME / CROMO



○△
9,3x9,2x35,6 CM / INCH 3.7x3.6x14

269 02 02

WASTE BIN
PAPELERA

GLOSSY STAINLESS STEEL / INOX BRILLO



5 L. / 20,5x20,5x30 CM / INCH 8x8x11.8

269 01 02

WASTE BIN
PAPELERA

CHROME / CROMO



5 L. / 20,5x20,5x30 CM / INCH 8x8x11.8



stick is the simplicity of good taste. A collection with 100% Bath+ DNA: modern, practical and functional.

The accessories, which can be white, black or chrome, stand out for their visual lightness. The flange serves as the base for their installation with Quick-Fix adhesive tape, without the need to drill.

A design for young people, urbanites, people who love clean spaces without complications. A fresh collection that includes hanging pieces such as towel bars or robe hooks, ideal for placing on furniture.

stick

stick es la simplicidad del buen gusto. Una colección con ADN 100% Bath+: moderna, práctica y funcional para los usuarios que buscan la comodidad en el cuarto de baño.

Los accesorios, que pueden ser blancos, negros o cromados, destacan por su ligereza visual. Su embellecedor sirve de base para su instalación con cinta adhesiva Quick-Fix, sin necesidad de taladrar.

Un diseño para jóvenes, urbanitas, amantes de los espacios limpios y sin complicaciones. Una colección fresca que incluye piezas colgantes como toalleros o perchas, ideales para colocar en muebles.

Design by





**EASY INSTALLATION
WITHOUT DRILLING**

FÁCIL INSTALACIÓN
SIN TALADRO



**BONDED WITH
HIGH ADHESION
ADHESIVE**

FIJACIÓN CON
ADHESIVO DE ALTA
ADHERENCIA



**STATIC LOAD
RESISTANCE
OF 5 KG**

RESISTENCIA
DE UNA CARGA
ESTÁTICA DE 5 KG



**PRODUCT
WITH A 10 YEAR
WARRANTY**

PRODUCTO
CON 10 AÑOS
DE GARANTÍA



**DO NOT USE ON
PAINTED SURFACES
AND GYPSUM WALLS**

NO USAR EN SUPERFICIES
PINTADAS NI EN
PAREDES RUGOSAS



VALENTÍ GARCIA

PRODUCT DESIGNER BATH+

1 What is stick? ¿Qué es stick?

It is a collection of bathroom accessories that seeks the purity of lines. The pieces are held up by flanges that stick to flat surfaces using adhesive tape. A proposal that is the antithesis of baroque, seeking a basic line with some differentiating detail.

Es una colección de accesorios para el baño que busca la pureza de las líneas. Las piezas se sustentan en unos embellecedores que se enganchan con cinta adhesiva a superficies planas. Es una propuesta que es la antítesis al barroco y que busca la línea básica con algún detalle diferenciador.

2 Perhaps the most differentiating detail is the shape of the towel ring?

¿Quizá el detalle más diferenciador es la forma del toallero aro, no?

Yes, its design is special due to its asymmetry. Although Stick is a set, I would venture to say that the towel ring is its banner piece. It plays a leading role for being a lopsided square ring.

Sí, su diseño es especial por su asimetría. Aunque Stick es un conjunto, me atrevería a decir que el toallero aro es su pieza estandarte. Tiene un papel protagonista por ser un aro cuadrado desigual.

3 How do you manage to give a sensation of lightness to bathroom accessories?

¿Cómo se consigue dar la sensación de ligereza en unos accesorios para el baño?

With very pure lines and trying to keep weight to a minimum, with some sinuous thicknesses. This means making the material do its job, with just the right volume to achieve visual lightness.

Con líneas muy puras e intentando tener el mínimo peso, con unos gruesos sinuosos. Se trata de que el material haga su función, con el volumen justo para conseguir la ligereza visual.

4 Visual lightness is a current trend?

¿La ligereza visual es una tendencia actual?

We are in a time when everything comes into play, you can find shapes with many curves where there are no sharp edges. But we are also looking back, towards Vintage. Yes, it's true that there is a school of thought that seeks the simplicity of shapes without renouncing design. Although I don't know if we can speak of a trend.

Estamos en un momento en el que todo juega, puedes encontrar formas con muchas curvas, en las que no hay aristas. Pero también estamos mirando atrás, hacia lo Vintage. Sí que es verdad que hay una corriente que busca la sencillez en las formas sin renunciar al diseño. Pero no sé si podemos hablar de tendencia.

5 How are the stick accessories installed?

¿Cómo se instalan los accesorios **stick**?

Their installation is quite simple. It is not necessary to drill holes in the wall, as they attach with Quick-Fix adhesive tape. Choose a flat surface and follow the instruction sheet. There are some pieces that can be hung on the side of the furniture, such as the towel bar.

Su instalación es muy sencilla. No hay que taladrar la pared si no que se engancha con cinta adhesiva Quick-Fix. Hay que elegir una superficie lisa y seguir las instrucciones del fabricante. También hay algunas piezas que se pueden colgar en el lateral del mueble, como el toallero.

6 What target group is this collection aimed at?

¿Para qué público está pensada esta colección?

It is intended for young urbanites who like clean spaces, the purity of shapes and who can then contrast with the colours to give it a different tone, a personality of its own.

Se dirige a gente joven y urbanita, que le gusta los espacios limpios, la pureza de formas y que luego pueden contrastar con los colores para darle un tono distinto, una personalidad propia.





276 01 21
HOOK
 COLGADOR
CHROME / CROMO



4,5x4,4x4,5 CM / INCH 1.8x1.7x1.8

276 01 22
DOUBLE HOOK
 COLGADOR DOBLE
CHROME / CROMO



11x4,4x4,5 CM / INCH 4.3x1.7x1.8

276 01 23
HOOK
 COLGADOR
CHROME / CROMO



2,5x6,6x7 CM / INCH 1x2.6x2.8

276 01 53
BRUSH-HOLDER
 PORTACEPILLOS
CHROME / CROMO



7,6x10,8x11,6 CM / INCH 3x4.3x4.6

COMBINE THE WALL TOWEL RING AND ROBE HOOK TO HANG ON THE FURNITURE AND YOU WILL HAVE A COMPLETELY FUNCTIONAL BATHROOM

COMBINA EL TOALLERO, LA ANILLA DE PARED Y LA PERCHA PARA COLGAR EN EL MUEBLE Y TENDRÁS UN BAÑO COMPLETAMENTE FUNCIONAL

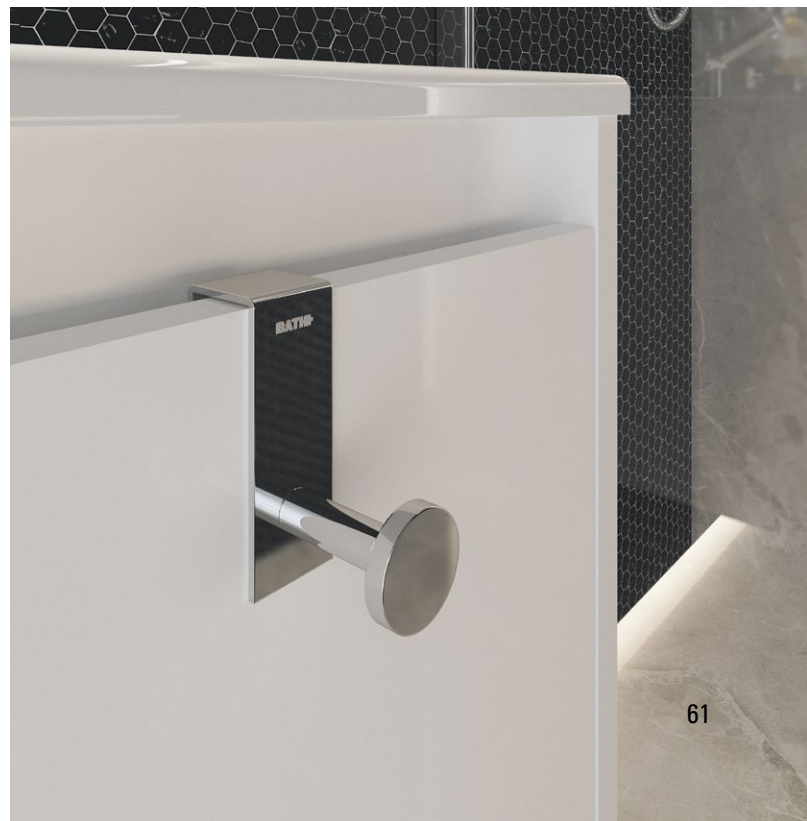

276 01 03
SOAP DISPENSER
DOSIFICADOR
CHROME / CROMO



200 ML



7,6x11,8x16,4 CM / INCH 3x4.7x6.5

276 01 49
BASKET
CONTAINER
CHROME / CROMO

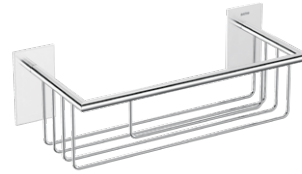

30,4x11,8x9,6 CM / INCH 12x4.7x3.8

276 01 71
TOWEL RING
TOALLERO ARO
CHROME / CROMO



25,5x10x7 CM / INCH 10x3.9x2.8

276 01 63
TOWEL RACK
TOALLERO
CHROME / CROMO



30x7x4,5 CM / INCH 11.8x2.8x1.8



276 01 64
TOWEL RACK
 TOALLERO
CHROME / CROMO



45x7x4,5 CM / INCH 17.7x2.8x1.8

276 01 65
TOWEL RACK
 TOALLERO
CHROME / CROMO



60x7x4,5 CM / INCH 23.6x2.8x1.8

276 01 66
TOWEL RACK
 TOALLERO
CHROME / CROMO



28x7x9,5 CM / INCH 11x2.8x3.7

276 01 67
TOWEL RACK
 TOALLERO
CHROME / CROMO



38x7x9,5 CM / INCH 15x2.8x3.7

276 01 44
GLASS SHELF
 ESTANTE VIDRIO
CHROME / CROMO



40x10,5x4,5 CM / INCH 15.8x4.1x1.8

276 01 69
TOWEL RACK
 TOALLERO
CHROME / CROMO



4,5x30,9x8 CM / INCH 1.8x12.2x3.2

276 01 58
PAPER HOLDER WITHOUT COVER
PORTAPAPEL SIN TAPA
CHROME / CROMO



15,2x7,6x4,5 CM / INCH 6x3x1.8

276 01 59
PAPER HOLDER WITH COVER
PORTAPAPEL CON TAPA
CHROME / CROMO



 
12,5x5,9x11,5 CM / INCH 4.9x2.3x4.5

276 01 96
PAPER HOLDER WITHOUT COVER
PORTAPAPEL SIN TAPA
CHROME / CROMO



4,5x14,4x4,5 CM / INCH 1.8x5.7x1.8

276 01 01
TOILET BRUSH
ESCOBILLERO PARED
CHROME / CROMO



 
7,6x10,7x38,3 CM / INCH 3x4.2x15.1



69 L'ABRI
TVÅL
Citrongrön

Aesop
MOUTHWASH
BAIN DE BOUCHE

Aesop
APOC

Aesop
MOUTHWASH
BAIN DE BOUCHE



276 65 21
HOOK
 COLGADOR
 MATTE WHITE / BLANCO MATE



4,5x4,4x4,5 CM / INCH 1.8x1.7x1.8

276 65 22
DOUBLE HOOK
 COLGADOR DOBLE
 MATTE WHITE / BLANCO MATE



11x4.4x4.5 CM / INCH 4.3x1.7x1.8

CREATE A LUMINOUS SPACE WITH ACCESSORIES THAT CAN BE INSTALLED WITH QUICK- FIX ADHESIVE TAPE, WITHOUT DRILLING HOLES IN THE WALL

CREA UN ESPACIO LUMINOSO
 CON ACCESORIOS QUE SE PUEDEN
 INSTALAR CON CINTA ADHESIVA
 QUICK-FIX, SIN TALADRAR LA PARED

276 65 23
HOOK
 COLGADOR
 MATTE WHITE / BLANCO MATE



2,5x6,6x7 CM / INCH 1x2.6x2.8





276 65 53
BRUSH-HOLDER
PORTACEPILLOS
MATTE WHITE / BLANCO MATE



7,6x10,8x11,6 CM / INCH 3x4.3x4.6

276 65 03
SOAP DISPENSER
DOSIFICADOR
MATTE WHITE / BLANCO MATE



200 ML



7,6x11,8x16.4CM / INCH 3x4.7x6.5

276 65 49
BASKET
CONTAINER
MATTE WHITE / BLANCO MATE



30,4x11,8x9,6 CM / INCH 12x4.7x3.8

276 65 71
TOWEL RING
TOALLERO ARO
MATTE WHITE / BLANCO MATE

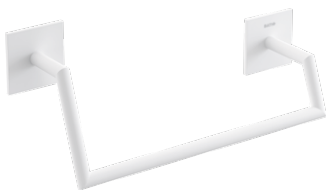

25,5x10x7CM / INCH 10x3.9x2.8

276 65 63
TOWEL RACK
TOALLERO
MATTE WHITE / BLANCO MATE



30x7x4,5 CM / INCH 11.8x2.8x1.8

276 65 64
TOWEL RACK
 TOALLERO
MATTE WHITE / BLANCO MATE



45x7x4,5 CM / INCH 17.7x2.8x1.8

276 65 65
TOWEL RACK
 TOALLERO
MATTE WHITE / BLANCO MATE



60x7x4,5 CM / INCH 23.6x2.8x1.8



276 65 66
TOWEL RACK
 TOALLERO
MATTE WHITE / BLANCO MATE



28x7x9,5 CM / INCH 11x2.8x3.7

276 65 67
TOWEL RACK
 TOALLERO
MATTE WHITE / BLANCO MATE



38x7x9,5 CM / INCH 15x2.8x3.7

276 65 44
GLASS SHELF
ESTANTE VIDRIO
MATTE WHITE / BLANCO MATE

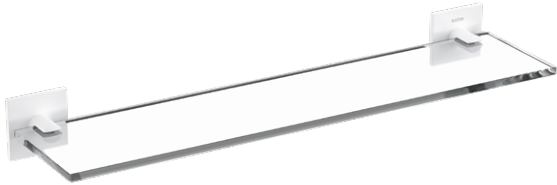

◆ ◻
40x10,5x4,5 CM / INCH 15.8x4.1x1.8

276 65 69
TOWEL RACK
TOALLERO
MATTE WHITE / BLANCO MATE



◻
4,5x30,9x8 CM / INCH 1.8x12.2x3.2

276 65 58
PAPER HOLDER WITHOUT COVER
PORTAPAPEL SIN TAPA
MATTE WHITE / BLANCO MATE



◻
15,2x7,6x4,5 CM / INCH 6x3x1.8

276 65 59
PAPER HOLDER WITH COVER
PORTAPAPEL CON TAPA
MATTE WHITE / BLANCO MATE



◻ ◻
12,5x5,9x11,5 CM / INCH 4.9x2.3x4.5

276 65 96
PAPER HOLDER WITHOUT COVER
PORTAPAPEL SIN TAPA
MATTE WHITE / BLANCO MATE



◻
4,5x14,4x4,5 CM / INCH 1.8x5.7x1.8

276 65 01
TOILET BRUSH
ESCOBILLERO PARED
MATTE WHITE / BLANCO MATE



◆ ◻
7,6x10,7x38,3 CM / INCH 3x4.2x15.1



BATH



276 36 21
HOOK
COLGADOR
MATTE BLACK / NEGRO MATE



4,5x4,4x4,5 CM / INCH 1.8x1.7x1.8

276 36 22
DOUBLE HOOK
COLGADOR DOBLE
MATTE BLACK / NEGRO MATE



11x4,4x4,5 CM / INCH 4.3x1.7x1.8

276 36 23
HOOK
COLGADOR
MATTE BLACK / NEGRO MATE



2,5x6,6x7 CM / INCH 1x2.6x2.8



**DECORATE YOUR BATHROOM
WITH LIGHT ACCESSORIES, AN
URBAN DESIGN THAT FOLLOWS
THE TREND IN BLACK**

DECORA TU CUARTO DE BAÑO
CON ACCESORIOS LIGEROS,
DE DISEÑO URBANO, QUE SIGUEN
LA TENDENCIA DEL COLOR NEGRO



276 36 53
BRUSH-HOLDER
PORTACEPILLOS
MATTE BLACK / NEGRO MATE



7,6x10,8x11,6 CM / INCH 3x4.3x4.6

276 36 03
SOAP DISPENSER
DOSIFICADOR
MATTE BLACK / NEGRO MATE



200 ML
7,6x11,8x16.4CM / INCH 3x4.7x6.5

276 36 49
BASKET
CONTAINER
MATTE BLACK / NEGRO MATE



30,4x11,8x9,6 CM / INCH 12x4.7x3.8

276 36 71
TOWEL RING
TOALLERO ARO
MATTE BLACK / NEGRO MATE

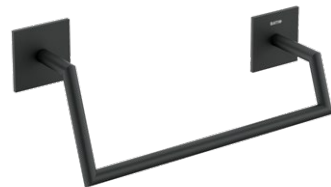

25,5x10x7CM / INCH 10x3.9x2.8

276 36 63
TOWEL RACK
TOALLERO
MATTE BLACK / NEGRO MATE



30x7x4,5 CM / INCH 11.8x2.8x1.8

276 36 64
TOWEL RACK
TOALLERO
MATTE BLACK / NEGRO MATE



45x7x4,5 CM / INCH 17.7x2.8x1.8

276 36 65
TOWEL RACK
TOALLERO
MATTE BLACK / NEGRO MATE



60x7x4,5 CM / INCH 23.6x2.8x1.8

276 36 66
TOWEL RACK
TOALLERO
MATTE BLACK / NEGRO MATE



28x7x9,5 CM / INCH 11x2.8x3.7

276 36 67
TOWEL RACK
TOALLERO
MATTE BLACK / NEGRO MATE



38x7x9,5 CM / INCH 15x2.8x3.7

276 36 44
GLASS SHELF
ESTANTE VIDRIO
MATTE BLACK / NEGRO MATE



40x10,5x4,5 CM / INCH 15.8x4.1x1.8

276 36 69
TOWEL RACK
TOALLERO
MATTE BLACK / NEGRO MATE



4,5x30,9x8 CM / INCH 1.8x12.2x3.2

276 36 58
PAPER HOLDER WITHOUT COVER
PORTAPAPEL SIN TAPA
MATTE BLACK / NEGRO MATE



15,2x7,6x4,5 CM / INCH 6x3x1.8

276 36 59
PAPER HOLDER WITH COVER
PORTAPAPEL CON TAPA
MATTE BLACK / NEGRO MATE



12,5x5,9x11,5 CM / INCH 4.9x2.3x4.5

276 36 96
PAPER HOLDER WITHOUT COVER
PORTAPAPEL SIN TAPA
MATTE BLACK / NEGRO MATE



4,5x14,4x4,5 CM / INCH 1.8x5.7x1.8

276 36 01
TOILET BRUSH
ESCOBILLERO PARED
MATTE BLACK / NEGRO MATE



7,6x10,7x38,3 CM / INCH 3x4.2x15.1



b-best is a furniture collection with washbasin designed for people who seek the comfort and functionality of everyday's life: the frenetic rhythms of life, the morning rush, and moments of relaxation at the end of the day; without forgetting design and aesthetics. People who perceive functionality in simplicity and minimalism, and beauty in order and harmony.

When centimetres count, you don't have to give up design and functionality. With **b-best** you can choose between 4 models of furniture and 2 washbasins, in different sizes to suit you and your needs.

A collection with 6 finishes to choose from, so that your bathroom is completely yours.

b-best

b-best es una colección de mobiliario con lavabo pensada para personas que buscan la comodidad y practicidad del día a día: de los ritmos de vida frenéticos, las prisas de la mañana, y los momentos de relax al final del día; sin dejar de lado el diseño y la estética. Personas que perciben la funcionalidad en la sencillez y el minimalismo, y la belleza en el orden y la armonía.

Cuando los centímetros cuentan, no tienes por qué renunciar al diseño y funcionalidad. Con **b-best** puedes escoger entre 4 modelos de muebles y 2 lavabos, de tamaños diferentes que se adaptan a ti y a tus necesidades.

Una colección que cuenta con 6 acabados a escoger, para que tu baño sea tuyo.

Design by



FSC Certified
products
Productos
certificados FSC







JAUME JUAN

PRODUCT DESIGNER BATH+

1 What is b-best? ¿Qué es b-best?

It's a collection of furniture with porcelain or Teckstone washbasin, designed to make the most of the space, but keeping a fresh and tidy aesthetic both inside and outside. This is possible thanks to its design, which also offers the possibility of providing the bathroom with a cupboard, mirrors of different sizes and shapes, and LED lighting.

Es una colección de mobiliario con lavabo de porcelana o en Teckstone, pensada para aprovechar al máximo el espacio, pero manteniendo una estética fresca y ordenada tanto interior como exteriormente. Esto es posible gracias a su diseño que, además, ofrece la posibilidad de equipar el baño con un armario, espejos de diferentes tamaños y formas, e iluminación de tipo led.

2 How does it differ from other solutions on the market?

¿En qué se diferencia del resto de soluciones del mercado?

The essential difference lies in the design and the wide range of structures and finishes. It stands out for having a very careful design, designed for its use and functionality. And for the range of options it offers to fit into any space and style.

Every decision in the design and development process has been taken with these premises in mind. To provide added value, as today's consumers are looking for economical solutions without sacrificing functionality and innovative design.

La diferencia esencial está en el diseño y la amplia gama de estructuras y acabados. Destaca por tener un diseño muy cuidado, pensado para su uso y funcionalidad. Y por el abanico de opciones que ofrece para encajar en cualquier espacio y estilo.

Cada decisión en el proceso de diseño y desarrollo se ha tomado teniendo en cuenta estas premisas. Para aportar un valor añadido, ya que hoy en día el consumidor busca soluciones económicas sin renunciar a la funcionalidad y al diseño innovador.

3 What does the collection offers to the bathroom?

¿Qué aporta la colección al baño?

The range is very complete, offering solutions from 60 cm to 120 cm wide. The smaller models make it possible to compact functionality in the minimum space to make the most of the square meters; on the other hand, with the larger models you can create a pleasant environment where you can share while keeping your individual space. It also provides a structured order both internally and externally, which brings harmony to the bathroom. Real bathrooms are full



of everyday items and it wants to make these everyday actions practical and simple with a fresh and friendly design.

One of the main characteristics is that, as it's designed, it can be adapted to the preferences of each customer. For example, you can choose on which side to place the cupboard and in which colour. And the set can be combined with the same finishes for the washbasin unit.

La gama es muy amplia, da soluciones desde 60 cm a 120 cm de ancho. Los modelos más pequeños permiten compactar funcionalidad en el mínimo espacio para aprovechar al máximo los metros cuadrados; por otro lado con los modelos más grandes se puede crear un entorno agradable donde poder compartir salvaguardando el espacio individual de cada uno. También proporciona un orden estructurado tanto interior como exteriormente, que aporta armonía al baño. Los baños reales están llenos de artículos de uso diario y quiere hacer prácticos y sencillos esos gestos cotidianos con un diseño fresco y cercano.

and a competitive price. The result is a collection that provides balance.

A todo aquel que tenga que amueblar su baño o quiera reformarlo, que no disponga de muchos metros cuadrados y además busque una solución económica sin renunciar al diseño. Los lavabos pueden ser de porcelana o Teckstone y los muebles fabricados en partículas de madera, aptos para cualquier espacio y estilo. Están disponibles en blanco, gris perla o gris urano brillo para aquellos que buscan una imagen más actual y en nogal natural, nogal ceniza o wengué café para los que quieran conseguir una mayor calidez y acercarse a la naturaleza.

Es una colección ideal para un público que quiere un orden funcional, tanto si decide tener sus utensilios a la vista como si prefiere tenerlos guardados en el mueble. El modo de vida actual pide soluciones eficaces y pragmáticas, **b-best** satisface estas necesidades, ofreciendo un diseño y un precio competitivo. El resultado es una colección que aporta equilibrio.

4 Who is your target customer?

¿A qué público va dirigido?

Anyone who has to furnish their bathroom or wants to renovate it, who does not have many square meters and is looking for an economical solution without sacrificing design. The washbasins can be made of porcelain or Teckstone and the furniture made of wood particles, suitable for any space and style. They're available in white, pearl grey or gloss uranium grey for those looking for a more contemporary image and in natural walnut, ash walnut or coffee wenge for those who want to achieve greater warmth and get closer to nature.

It's an ideal collection for a public that wants functional order, whether they decide to keep their utensils in view or prefer to keep them stored in the furniture. Today's lifestyle demands efficient and pragmatic solutions, and b-best meets these needs, offering a design

5 Does it design intended to create a trend or to meet existing needs?

¿Su diseño está pensado para crear una tendencia o para satisfacer unas necesidades ya existentes?

From gathering real needs, we have been able to create a design that has all the ingredients to be a trend. We realized that we had to offer solutions to achieve a practical order and we created b-best.

A partir de recoger unas necesidades reales hemos sido capaces de crear un diseño que tiene todos los ingredientes para ser tendencia. Nos dimos cuenta de que debíamos ofrecer soluciones para conseguir un orden práctico y creamos **b-best**.





WASHBASINS IN DIFFERENT SHAPES AND MATERIALS AND UP TO 4 FURNITURE MODELS OF 60, 80, 100 OR 120 CM WITH A CASUAL DESIGN: RECTANGULAR BASIN IN PORCELAIN AND RECTANGULAR BASIN IN TECKSTONE WITH A SPACE FOR ACCESSORIES

LAVABOS DE FORMAS Y MATERIALES DIFERENTES Y HASTA 4 MODELOS DE MOBILIARIO DE 60, 80, 100 O 120 CM CON UN DISEÑO DESENFADADO: SENO RECTANGULAR EN PORCELANA Y SENO RECTANGULAR EN TECKSTONE CON UN ESPACIO DESTINADO A LOS ACCESORIOS





**CREATE A COMFORTABLE
ATMOSPHERE TO
SHARE THE ROOM**

CREA UN AMBIENTE
COMFORTABLE DONDE
COMPARTIR EL ESPACIO







**GET MORE STORAGE
SPACE, EASY AND
COMFORTABLE TO TIDY UP**

CONSIGUE MAYOR
CAPACIDAD, ORDENA
FÁCIL Y CÓMODAMENTE



1 DRAWER AND 1 DECORATIVE CABINET WITH TECKSTONE WASHBASIN

MUEBLE 1 CAJÓN Y 1 DECORATIVO CON LAVABO TECKSTONE

Finishes

Acabados



229
GLOSSY WHITE
BLANCO BRILLO



230
PEARL GREY
GRIS PERLA



231
URANUS GREY
GRIS URANO



232
NATURAL WALNUT
NOGAL NATURAL



233
WALNUT ASH
NOGAL CENIZA



234
WENGUE COFFEE
WENGÜE CAFÉ

PACK RANGE: cabinet + teckstone washbasin + mirror + LED lighting

GAMA PACK: mueble + lavabo teckstone + espejo + iluminación LED

**B040610010601**

**1 DRAWER AND 1
DECORATIVE CABINET WITH
TECKSTONE WASHBASIN +
MIRROR 60x80 CM +
WALL LAMP 28 CM 6W
(EBIR E27384CI)**

MUEBLE 1 CAJÓN Y
1 DECORATIVO CON
LAVABO TECKSTONE +
ESPEJO 60x80 CM +
APLIQUE 28 CM LED 6W
(EBIR E27384CI)



60 CM
INCH 23.6

**B040810010801**

**1 DRAWER AND 1
DECORATIVE CABINET WITH
TECKSTONE WASHBASIN +
MIRROR 80x80 CM +
WALL LAMP 28 CM 6W
(EBIR E27384CI)**

MUEBLE 1 CAJÓN Y
1 DECORATIVO CON
LAVABO TECKSTONE +
ESPEJO 80x80 CM +
APLIQUE 28 CM LED 6W
(EBIR E27384CI)



80 CM
INCH 31.5

**B041010011001**

**1 DRAWER AND 1
DECORATIVE CABINET WITH
TECKSTONE WASHBASIN +
MIRROR 100x80 CM +
WALL LAMP 28 CM 6W
(EBIR E27384CI)**

MUEBLE 1 CAJÓN Y
1 DECORATIVO CON
LAVABO TECKSTONE +
ESPEJO 100x80 CM +
APLIQUE 28 CM LED 6W
(EBIR E27384CI)



100 CM
INCH 39.4

**B041210011201**

**2 DRAWER AND 2
DECORATIVE CABINET WITH
TECKSTONE WASHBASIN +
MIRROR 120x80 CM +
2 WALL LIGHTS 28CM 6W
(EBIR E27384CI)**

MUEBLE 2 CAJONES Y
2 DECORATIVOS CON
LAVABO TECKSTONE +
ESPEJO 120x80 CM +
2 APLIQUES 28CM LED 6W
(EBIR E27384CI)



120 CM
INCH 47.2

This pack includes 2 led wall lights
Este pack incluye 2 apliques

*** Valve and trap not included**
Válvula y sifón no incluidos

UNIK RANGE: cabinet + teckstone washbasin

GAMA UNIK: mueble + lavabo teckstone

B10010601_____

1 DRAWER AND 1 DECORATIVE CABINET WITH TECKSTONE WASHBASIN 60 CM
MUEBLE 1 CAJÓN Y 1 DECORATIVO CON LAVABO TECKSTONE 60 CM



60x45x90 CM / INCH 23.6x17.7x35.4

B10010801_____

1 DRAWER AND 1 DECORATIVE CABINET WITH TECKSTONE WASHBASIN 80 CM
MUEBLE 1 CAJÓN Y 1 DECORATIVO CON LAVABO TECKSTONE 80 CM



80x45x90 CM / INCH 31.5x17.7x35.4

B10011001_____

1 DRAWER AND 1 DECORATIVE CABINET WITH TECKSTONE WASHBASIN 100 CM
MUEBLE 1 CAJÓN Y 1 DECORATIVO CON LAVABO TECKSTONE 100 CM



100x45x90 CM / INCH 39.4x17.7x35.4

B10011201_____

2 DRAWER AND 2 DECORATIVE CABINET WITH TECKSTONE WASHBASIN 120 CM
MUEBLE 2 CAJONES Y 2 DECORATIVOS CON LAVABO TECKSTONE 120 CM



120x45x90 CM / INCH 47.2x17.7x35.4



B1005_____

CABINET
ARMARIO

The cabinet includes 4 shelves.
Reversible door.
El armario incluye 4 estantes.
Puerta reversible.



30x24x150 CM / INCH 11.8x9.4x59



B07104001

LEGS SET x2
CONJUNTO DE PATAS x2
GLOSSY SILVER / PLATA BRILLO



3,5x3,5x27 CM / INCH 1.3x1.3x10.6

Mirrors and LED wall lamps

Espejos y apliques LED

B01001004 50 CM
B01001001 60 CM
B01001002 80 CM
B01001003 100 CM
B01001005 120 CM

MIRROR
ESPEJO



50-60-80-100-120x80 CM / INCH 19.7-23.6-31.5-39.4-47.2x31.5

B01001006 60 CM
B01001007 80 CM
B01001008 100 CM
B01001009 120 CM

MIRROR
ESPEJO



60/80/100/120x80 CM / INCH 23.6/31.5/39.4/47.2x31.5

B02007007 28 CM
B02008008 49,4 CM

LED WALL LAMP
APLIQUE LED



› □ IP44 LEDS 1X6W - 4000k "NATURAL WHITE" - INPUT 240v
 28-49,4x10,7x2,9 CM / INCH 11-19.4x4.2x1.1

B02014014 80 CM
B02015015 100 CM

LED WALL LAMP
APLIQUE LED



› □ IP44 LEDS 1X10-1X15 - 4000k "NATURAL WHITE" - INPUT 220V
 80-100x10,7x2,9 CM / INCH 31.5-39.4x4.2x1.1

2 DRAWER CABINET WITH TECKSTONE WASHBASIN

MUEBLE 2 CAJONES CON LAVABO TECKSTONE

Finishes

Acabados



229
GLOSSY WHITE
BLANCO BRILLO



230
PEARL GREY
GRIS PERLA



231
URANUS GREY
GRIS URANO



232
NATURAL WALNUT
NOGAL NATURAL



233
WALNUT ASH
NOGAL CENIZA



234
WENGUE COFFEE
WENGÜE CAFÉ

PACK RANGE: cabinet + teckstone washbasin + mirror + LED lighting

GAMA PACK: mueble + lavabo teckstone + espejo + iluminación LED

**B040610020601**

**2 DRAWER CABINET WITH
TECKSTONE WASHBASIN +
MIRROR 60x80 CM +
WALL LAMP 28 CM 6W
(EBIR E27384CI)**

MUEBLE 2 CAJONES
CON LAVABO TECKSTONE +
ESPEJO 60x80 CM +
APLIQUE 28 CM LED 6W
(EBIR E27384CI)



60 CM
INCH 23.6

**B040810020801**

**2 DRAWER CABINET WITH
TECKSTONE WASHBASIN +
MIRROR 80x80 CM +
WALL LAMP 28 CM 6W
(EBIR E27384CI)**

MUEBLE 2 CAJONES
CON LAVABO TECKSTONE +
ESPEJO 80x80 CM +
APLIQUE 28 CM LED 6W
(EBIR E27384CI)



80 CM
INCH 31.5

**B041010021001**

**2 DRAWER CABINET WITH
TECKSTONE WASHBASIN +
MIRROR 100x80 CM +
WALL LAMP 28 CM 6W
(EBIR E27384CI)**

MUEBLE 2 CAJONES
CON LAVABO TECKSTONE +
ESPEJO 100x80 CM +
APLIQUE 28 CM LED 6W
(EBIR E27384CI)



100 CM
INCH 39.4

**B041210021201**

**4 DRAWER CABINET WITH
TECKSTONE WASHBASIN +
MIRROR 120x80 CM +
2 WALL LIGHTS 28 CM 6W
(EBIR E27384CI)**

MUEBLE 4 CAJONES
CON LAVABO TECKSTONE +
ESPEJO 120x80 CM +
2 APLIQUES 28 CM LED 6W
(EBIR E27384CI)



120 CM
INCH 47.2



This pack includes 2 led wall lights
Este pack incluye 2 apliques

*** Valve and trap not included**
Válvula y sifón no incluidos

UNIK RANGE: cabinet + teckstone washbasin

GAMA UNIK: mueble + lavabo teckstone

B10020601_____

2 DRAWER CABINET WITH TECKSTONE WASHBASIN 60 CM
MUEBLE 2 CAJONES CON LAVABO TECKSTONE 60 CM



60x45x90 CM / INCH 23.6x17.7x35.4

B10020801_____

2 DRAWER CABINET WITH TECKSTONE WASHBASIN 80 CM
MUEBLE 2 CAJONES CON LAVABO TECKSTONE 80 CM



80x45x90 CM / INCH 31.5x17.7x35.4

B10021001_____

2 DRAWER CABINET WITH TECKSTONE WASHBASIN 100 CM
MUEBLE 2 CAJONES CON LAVABO TECKSTONE 100 CM



100x45x90 CM / INCH 39.4x17.7x35.4

B10021201_____

4 DRAWER CABINET WITH TECKSTONE WASHBASIN 120 CM
MUEBLE 4 CAJONES CON LAVABO TECKSTONE 120 CM



120x45x90 CM / INCH 47.2x17.7x35.4



B1005_____

CABINET
ARMARIO

The cabinet includes 4 shelves.
Reversible door.
El armario incluye 4 estantes.
Puerta reversible.



30x24x150 CM / INCH 11.8x9.4x59



B07104001

LEGS SET x2
CONJUNTO DE PATAS x2
GLOSSY SILVER / PLATA BRILLO



3,5x3,5x27 CM / INCH 1.3x1.3x10.6

Mirrors and LED wall lamps

Espejos y apliques LED

B01001004 50 CM
B01001001 60 CM
B01001002 80 CM
B01001003 100 CM
B01001005 120 CM

MIRROR
 ESPEJO



50-60-80-100-120x80 CM / INCH 19.7-23.6-31.5-39.4-47.2x31.5

B01001006 60 CM
B01001007 80 CM
B01001008 100 CM
B01001009 120 CM

MIRROR
 ESPEJO



60/80/100/120x80 CM / INCH 23.6/31.5/39.4/47.2x31.5

B02007007 28 CM
B02008008 49,4 CM

LED WALL LAMP
 APLIQUE LED



› □ IP44 LEDS 1X6W - 4000k "NATURAL WHITE" - INPUT 240v
 28-49,4x10,7x2,9 CM / INCH 11-19.4x4.2x1.1

B02014014 80 CM
B02015015 100 CM

LED WALL LAMP
 APLIQUE LED



› □ IP44 LEDS 1X10-1X15 - 4000k "NATURAL WHITE" - INPUT 220V
 80-100x10,7x2,9 CM / INCH 31.5-39.4x4.2x1.1

2 DOOR / 3 DRAWER CABINET WITH TECKSTONE WASHBASIN

MUEBLE 2 PUERTAS / 3 CAJONES CON LAVABO TECKSTONE

Finishes

Acabados



229
GLOSSY WHITE
BLANCO BRILLO



230
PEARL GREY
GRIS PERLA



231
URANUS GREY
GRIS URANO



232
NATURAL WALNUT
NOGAL NATURAL



233
WALNUT ASH
NOGAL CENIZA



234
WENGUE COFFEE
WENGÜE CAFÉ

PACK RANGE: cabinet + teckstone washbasin + mirror + LED lighting

GAMA PACK: mueble + lavabo teckstone + espejo + iluminación LED

**B040610040601** _____

**2 DOOR CABINET WITH
TECKSTONE WASHBASIN +
MIRROR 60x80 CM +
WALL LAMP 28 CM 6W
(EBIR E27384CI)**

MUEBLE 2 PUERTAS CON
LAVABO TECKSTONE +
ESPEJO 60x80 CM +
APLIQUE 28 CM LED 6W
(EBIR E27384CI)



60 CM
INCH 23.6

**B040810040801** _____

**2 DOOR CABINET WITH
TECKSTONE WASHBASIN +
MIRROR 80x80 CM +
WALL LAMP 28 CM 6W
(EBIR E27384CI)**

MUEBLE 2 PUERTAS +
LAVABO TECKSTONE +
ESPEJO 80x80 CM +
APLIQUE 28 CM LED 6W
(EBIR E27384CI)



80 CM
INCH 31.5

**B040810030801** _____

**3 DRAWER CABINET
WITH LEGS WITH
TECKSTONE WASHBASIN +
MIRROR 80x80 CM +
WALL LAMP 28 CM 6W
(EBIR E27384CI)**

MUEBLE 3 CAJONES CON PATAS
CON LAVABO TECKSTONE +
ESPEJO 80x80 CM +
APLIQUE 28 CM LED 6W
(EBIR E27384CI)



80 CM
INCH 31.5

**B041010031001** _____

**3 DRAWER CABINET
WITH LEGS WITH
TECKSTONE WASHBASIN +
MIRROR 100x80 CM +
WALL LAMP 28 CM 6W
(EBIR E27384CI)**

MUEBLE 3 CAJONES CON PATAS
CON LAVABO TECKSTONE +
ESPEJO 100x80 CM +
APLIQUE 28 CM LED 6W
(EBIR E27384CI)



100 CM
INCH 39.4

*** Valve and trap not included**
Válvula y sifón no incluidos

UNIK RANGE: cabinet + teckstone washbasin

GAMA UNIK: mueble + lavabo teckstone

B10040601

CABINET 2 DOORS WITH TECKSTONE WASHBASIN 60 CM
MUEBLE 2 PUERTAS CON LAVABO TECKSTONE 60 CM



60x45x90 CM / INCH 23.6x17.7x35.4

B10040801

CABINET 2 DOORS WITH TECKSTONE WASHBASIN 80 CM
MUEBLE 2 PUERTAS CON LAVABO TECKSTONE 80 CM



80x45x90 CM / INCH 31.5x17.7x35.4

B10030801

CABINET 3 DRAWERS WITH LEGS WITH TECKSTONE WASHBASIN 80 CM
MUEBLE 3 CAJONES CON PATAS CON LAVABO TECKSTONE 80 CM



80x45x90 CM / INCH 31.5x17.7x35.4

B10031001

CABINET 3 DRAWERS WITH LEGS WITH TECKSTONE WASHBASIN 100 CM
MUEBLE 3 CAJONES CON PATAS CON LAVABO TECKSTONE 100 CM



100x45x90 CM / INCH 39.4x17.7x35.4

B1005

CABINET
ARMARIO

The cabinet includes 4 shelves.
Reversible door.
El armario incluye 4 estantes.
Puerta reversible.



30x24x150 CM / INCH 11.8x9.4x59



B07104001

LEGS SET x2
CONJUNTO DE PATAS x2
GLOSSY SILVER / PLATA BRILLO



3,5x3,5x27 CM / INCH 1.3x1.3x10.6

Mirrors and LED wall lamps

Espejos y apliques LED

B01001004 50 CM
B01001001 60 CM
B01001002 80 CM
B01001003 100 CM
B01001005 120 CM

MIRROR
 ESPEJO



50-60-80-100-120x80 CM / INCH 19.7-23.6-31.5-39.4-47.2x31.5

B01001006 60 CM
B01001007 80 CM
B01001008 100 CM
B01001009 120 CM

MIRROR
 ESPEJO



60/80/100/120x80 CM / INCH 23.6/31.5/39.4/47.2x31.5

B02007007 28 CM
B02008008 49,4 CM

LED WALL LAMP
 APLIQUE LED



› □ IP44 LEDS 1X6W - 4000k "NATURAL WHITE" - INPUT 240v
 28-49,4x10,7x2,9 CM / INCH 11-19.4x4.2x1.1

B02014014 80 CM
B02015015 100 CM

LED WALL LAMP
 APLIQUE LED



› □ IP44 LEDS 1X10-1X15 - 4000k "NATURAL WHITE" - INPUT 220V
 80-100x10,7x2,9 CM / INCH 31.5-39.4x4.2x1.1





**ALWAYS HAVE YOUR
EVERYDAY ITEMS AT
HAND IN A PRACTICAL
AND SIMPLE WAY**

TEN SIEMPRE A MANO
TUS ARTÍCULOS DE USO
DIARIO DE MANERA
PRÁCTICA Y SENCILLA



**A COLLECTION
WITH A CASUAL
DESIGN THAT
CONVEYS
FRESHNESS**

UNA COLECCIÓN
CON UN DISEÑO
ACUTAL QUE
TRANSMITE
FRESCURA





A tall, dark grey, minimalist cabinet with a vertical split design, positioned on the left side of the vanity area.

A large, round, gold-rimmed mirror mounted on the wall above the vanity, reflecting the white door behind it.

A dark grey vanity unit with a white countertop, featuring two sinks and two black faucets. Below the countertop are two open shelves containing folded towels.

A shower area with a glass door and a wall featuring a geometric patterned tile design. A dark grey towel is hanging on a rack inside the shower.

A white toilet is partially visible on the left side of the image.

A dark grey, textured rug placed on the floor near the vanity and shower area.



**TURN YOUR
BATHROOM INTO
YOUR FAVOURITE
CORNER**

CONVIERTE
TU BAÑO
EN TU RINCÓN
FAVORITO

1 DRAWER AND 1 DECORATIVE CABINET WITH PORCELAIN WASHBASIN

MUEBLE 1 CAJÓN Y 1 DECORATIVO CON LAVABO DE PORCELANA

Finishes

Acabados



229
GLOSSY WHITE
BLANCO BRILLO



230
PEARL GREY
GRIS PERLA



231
URANUS GREY
GRIS URANO



232
NATURAL WALNUT
NOGAL NATURAL



233
WALNUT ASH
NOGAL CENIZA



234
WENGUE COFFEE
WENGÜE CAFÉ

PACK RANGE: cabinet + porcelain washbasin + mirror + LED lighting

GAMA PACK: mueble + lavabo de porcelana + espejo + iluminación LED

**B040610010615** _____

**1 DRAWER AND 1
DECORATIVE CABINET WITH
PORCELAIN WASHBASIN +
MIRROR 60x80 CM +
WALL LAMP 28 CM 6W
(EBIR E27384CI)**

MUEBLE 1 CAJÓN Y
1 DECORATIVO CON
LAVABO DE PORCELANA +
ESPEJO 60x80 CM +
APLIQUE 28 CM LED 6W
(EBIR E27384CI)



60 CM
INCH 23.6

**B040810010815** _____

**1 DRAWER AND 1
DECORATIVE CABINET WITH
PORCELAIN WASHBASIN +
MIRROR 80x80 CM +
WALL LAMP 28 CM 6W
(EBIR E27384CI)**

MUEBLE 1 CAJÓN Y
1 DECORATIVO CON
LAVABO DE PORCELANA +
ESPEJO 80x80 CM +
APLIQUE 28 CM LED 6W
(EBIR E27384CI)



80 CM
INCH 31.5

**B041010011015** _____

**1 DRAWER AND 1
DECORATIVE CABINET WITH
PORCELAIN WASHBASIN +
MIRROR 100x80 CM +
WALL LAMP 28 CM 6W
(EBIR E27384CI)**

MUEBLE 1 CAJÓN Y
1 DECORATIVO CON
LAVABO DE PORCELANA +
ESPEJO 100x80 CM +
APLIQUE 28 CM LED 6W
(EBIR E27384CI)



100 CM
INCH 39.4

**B041210011215** _____

**2 DRAWER AND 2
DECORATIVE CABINET WITH
PORCELAIN WASHBASIN +
MIRROR 120x80 CM +
2 WALL LIGHTS 28 CM
6W (EBIR E27384CI)**

MUEBLE 2 CAJONES Y
2 DECORATIVOS CON
LAVABO DE PORCELANA +
ESPEJO 120x80 CM +
2 APLIQUES 28 CM LED 6W
(EBIR E27384CI)



120 CM
INCH 47.2

This pack includes 2 led wall lights
Este pack incluye 2 apliques

*** Valve and trap not included**
Válvula y sifón no incluidos

UNIK RANGE: cabinet + porcelain washbasin

GAMA UNIK: mueble + lavabo de porcelana

B10010615

1 DRAWER AND 1 DECORATIVE CABINET WITH PORCELAIN WASHBASIN 60 CM
MUEBLE 1 CAJÓN Y 1 DECORATIVO CON LAVABO DE PORCELANA 60 CM



60x45x58 CM / INCH 23.6x17.7x22.8

B10010815

1 DRAWER AND 1 DECORATIVE CABINET WITH PORCELAIN WASHBASIN 80 CM
MUEBLE 1 CAJÓN Y 1 DECORATIVO CON LAVABO DE PORCELANA 80 CM



80x45x58 CM / INCH 31.5x17.7x22.8

B10011015

1 DRAWER AND 1 DECORATIVE CABINET WITH PORCELAIN WASHBASIN 100 CM
MUEBLE 1 CAJÓN Y 1 DECORATIVO CON LAVABO DE PORCELANA 100 CM



100x45x58 CM / INCH 39.4x17.7x22.8

B10011215

2 DRAWER AND 2 DECORATIVE CABINET WITH PORCELAIN WASHBASIN 120 CM
MUEBLE 2 CAJONES Y 2 DECORATIVOS CON LAVABO DE PORCELANA 120 CM



120x45x58 CM / INCH 47.2x17.7x22.8



B1005

CABINET
ARMARIO

The cabinet includes 4 shelves.
Reversible door.
El armario incluye 4 estantes.
Puerta reversible.



30x24x150 CM / INCH 11.8x9.4x59



B07104001

LEGS SET x2
CONJUNTO DE PATAS x2
GLOSSY SILVER / PLATA BRILLO



3,5x3,5x27 CM / INCH 1.3x1.3x10.6

Mirrors and LED wall lamps

Espejos y apliques LED

B01001004 50 CM
B01001001 60 CM
B01001002 80 CM
B01001003 100 CM
B01001005 120 CM

MIRROR
ESPEJO



50-60-80-100-120x80 CM / INCH 19.7-23.6-31.5-39.4-47.2x31.5

B01001006 60 CM
B01001007 80 CM
B01001008 100 CM
B01001009 120 CM

MIRROR
ESPEJO



60/80/100/120x80 CM / INCH 23.6/31.5/39.4/47.2x31.5

B02007007 28 CM
B02008008 49,4 CM

LED WALL LAMP
APLIQUE LED



›  IP44 LEDS 1X6W - 4000k "NATURAL WHITE" - INPUT 240v
 28-49,4x10,7x2,9 CM / INCH 11-19.4x4.2x1.1

B02014014 80 CM
B02015015 100 CM

LED WALL LAMP
APLIQUE LED



›  IP44 LEDS 1X10-1X15 - 4000k "NATURAL WHITE" - INPUT 220V
 80-100x10,7x2,9 CM / INCH 31.5-39.4x4.2x1.1

2 DRAWER CABINET WITH PORCELAIN WASHBASIN

MUEBLE 2 CAJONES CON LAVABO DE PORCELANA

Finishes

Acabados



229
GLOSSY WHITE
BLANCO BRILLO



230
PEARL GREY
GRIS PERLA



231
URANUS GREY
GRIS URANO



232
NATURAL WALNUT
NOGAL NATURAL



233
WALNUT ASH
NOGAL CENIZA



234
WENGUE COFFEE
WENGÜE CAFÉ

PACK RANGE: cabinet + porcelain washbasin + mirror + LED lighting

GAMA PACK: mueble + lavabo de porcelana + espejo + iluminación LED

**B040610020615**

**2 DRAWER CABINET WITH
PORCELAIN WASHBASIN +
MIRROR 60x80 CM +
WALL LAMP 28 CM 6W
(EBIR E27384CI)**

MUEBLE 2 CAJONES CON
LAVABO DE PORCELANA +
ESPEJO 60x80 CM +
APLIQUE 28 CM LED 6W
(EBIR E27384CI)



60 CM
INCH 23.6

**B040810020815**

**2 DRAWER CABINET WITH
PORCELAIN WASHBASIN +
MIRROR 80x80 CM +
WALL LAMP 28 CM 6W
(EBIR E27384CI)**

MUEBLE 2 CAJONES CON
LAVABO DE PORCELANA +
ESPEJO 80x80 CM +
APLIQUE 28 CM LED 6W
(EBIR E27384CI)



80 CM
INCH 31.5

**B041010021015**

**2 DRAWER CABINET WITH
PORCELAIN WASHBASIN +
MIRROR 100x80 CM +
WALL LAMP 28 CM 6W
(EBIR E27384CI)**

MUEBLE 2 CAJONES CON
LAVABO DE PORCELANA +
ESPEJO 100x80 CM +
APLIQUE 28 CM LED 6W
(EBIR E27384CI)



100 CM
INCH 39.4

**B041210021215**

**4 DRAWER CABINET WITH
PORCELAIN WASHBASIN +
MIRROR 120x80 CM +
2 WALL LIGHTS 28 CM 6W
(EBIR E27384CI)**

MUEBLE 4 CAJONES CON
LAVABO DE PORCELANA +
ESPEJO 120x80 CM +
2 APLIQUES 28 CM LED 6W
(EBIR E27384CI)



120 CM
INCH 47.2

This pack includes 2 led wall lights
Este pack incluye 2 apliques

*** Valve and trap not included**
Válvula y sifón no incluidos

UNIK RANGE: cabinet + porcelain washbasin

GAMA UNIK: mueble + lavabo de porcelana

B10020615 ___

2 DRAWER CABINET WITH PORCELAIN WASHBASIN 60 CM
MUEBLE 2 CAJONES CON LAVABO DE PORCELANA 60 CM



60x45x58 CM / INCH 23.6x17.7x22.8

B10020815 ___

2 DRAWER CABINET WITH PORCELAIN WASHBASIN 80 CM
MUEBLE 2 CAJONES CON LAVABO DE PORCELANA 80 CM



80x45x58 CM / INCH 31.5x17.7x22.8

B10021015 ___

2 DRAWER CABINET WITH PORCELAIN WASHBASIN 100 CM
MUEBLE 2 CAJONES CON LAVABO DE PORCELANA 100 CM



100x45x58 CM / INCH 39.4x17.7x22.8

B10021215 ___

4 DRAWER CABINET WITH PORCELAIN WASHBASIN 120 CM
MUEBLE 4 CAJONES CON LAVABO DE PORCELANA 120 CM



120x45x58 CM / INCH 47.2x17.7x22.8



B1005 ___

CABINET
ARMARIO

The cabinet includes 4 shelves.
Reversible door.
El armario incluye 4 estantes.
Puerta reversible.



30x24x150 CM / INCH 11.8x9.4x59



B07104001

LEGS SET x2
CONJUNTO DE PATAS x2
GLOSSY SILVER / PLATA BRILLO



3,5x3,5x27 CM / INCH 1.3x1.3x10.6

Mirrors and LED wall lamps

Espejos y apliques LED

B01001004 50 CM
B01001001 60 CM
B01001002 80 CM
B01001003 100 CM
B01001005 120 CM

MIRROR
ESPEJO



50-60-80-100-120x80 CM / INCH 19.7-23.6-31.5-39.4-47.2x31.5

B01001006 60 CM
B01001007 80 CM
B01001008 100 CM
B01001009 120 CM

MIRROR
ESPEJO



60/80/100/120x80 CM / INCH 23.6/31.5/39.4/47.2x31.5

B02007007 28 CM
B02008008 49,4 CM

LED WALL LAMP
APLIQUE LED



› IP44 LEDS 1X6W - 4000k "NATURAL WHITE" - INPUT 240v
 28-49,4x10,7x2,9 CM / INCH 11-19.4x4.2x1.1

B02014014 80 CM
B02015015 100 CM

LED WALL LAMP
APLIQUE LED



› IP44 LEDS 1X10-1X15 - 4000k "NATURAL WHITE" - INPUT 220V
 80-100x10,7x2,9 CM / INCH 31.5-39.4x4.2x1.1

2 DOOR / 3 DRAWER CABINET WITH PORCELAIN WASHBASIN

MUEBLE 2 PUERTAS / 3 CAJONES CON LAVABO DE PORCELANA

Finishes

Acabados



229
GLOSSY WHITE
BLANCO BRILLO



230
PEARL GREY
GRIS PERLA



231
URANUS GREY
GRIS URANO



232
NATURAL WALNUT
NOGAL NATURAL



233
WALNUT ASH
NOGAL CENIZA



234
WENGUE COFFEE
WENGÜE CAFÉ

PACK RANGE: cabinet + porcelain washbasin + mirror + LED lighting

GAMA PACK: mueble + lavabo de porcelana + espejo + iluminación LED

**B040610040615** _____

**2 DOOR CABINET WITH
PORCELAIN WASHBASIN +
MIRROR 60x80 CM +
WALL LAMP 28 CM 6W
(EBIR E27384CI)**

MUEBLE 2 PUERTAS CON
LAVABO DE PORCELANA +
ESPEJO 60x80 CM +
APLIQUE 28 CM LED 6W
(EBIR E27384CI)



60 CM
INCH 23.6

**B040810040815** _____

**C2 DOOR CABINET WITH
PORCELAIN WASHBASIN +
MIRROR 80x80 CM +
WALL LAMP 28 CM 6W
(EBIR E27384CI)**

MUEBLE 2 PUERTAS +
LAVABO DE PORCELANA +
ESPEJO 80x80 CM +
APLIQUE 28 CM LED 6W
(EBIR E27384CI)



80 CM
INCH 31.5

**B040810030815** _____

**3 DRAWER CABINET
WITH LEGS WITH
PORCELAIN WASHBASIN +
MIRROR 80x80 CM +
WALL LAMP 28 CM 6W
(EBIR E27384CI)**

MUEBLE 3 CAJONES CON PATAS
CON LAVABO DE PORCELANA +
ESPEJO 80x80 CM +
APLIQUE 28 CM LED 6W
(EBIR E27384CI)



80 CM
INCH 31.5

**B041010031015** _____

**3 DRAWER CABINET
WITH LEGS WITH
PORCELAIN WASHBASIN +
MIRROR 100x80 CM +
WALL LAMP 28 CM 6W
(EBIR E27384CI)**

MUEBLE 3 CAJONES CON PATAS
CON LAVABO DE PORCELANA +
ESPEJO 100x80 CM +
APLIQUE 28 CM LED 6W
(EBIR E27384CI)



100 CM
INCH 39.4

*** Valve and trap not included**
Válvula y sifón no incluidos

UNIK RANGE: cabinet + porcelain washbasin

GAMA UNIK: mueble + lavabo de porcelana

B10040615

2 DOOR CABINET WITH PORCELAIN WASHBASIN 60 CM
MUEBLE 2 PUERTAS CON LAVABO DE PORCELANA 60 CM



60x45x58 CM / INCH 23.6x17.7x22.8

B10040815

2 DOOR CABINET WITH PORCELAIN WASHBASIN 80 CM
MUEBLE 2 PUERTAS CON LAVABO DE PORCELANA 80 CM



80x45x58 CM / INCH 31.5x17.7x22.8

B10030815

3 DRAWER CABINET WITH LEGS WITH PORCELAIN WASHBASIN 80 CM
MUEBLE 3 CAJONES CON PATAS CON LAVABO DE PORCELANA 80 CM



80x45x58 CM / INCH 31.5x17.7x22.8

B10031015

3 DRAWER CABINET WITH LEGS WITH PORCELAIN WASHBASIN 100 CM
MUEBLE 3 CAJONES CON PATAS CON LAVABO DE PORCELANA 100 CM



100x45x58 CM / INCH 39.4x17.7x22.8

B1005

CABINET
ARMARIO

The cabinet includes 4 shelves.
Reversible door.
El armario incluye 4 estantes.
Puerta reversible.



30x24x150 CM / INCH 11.8x9.4x59



B07104001

LEGS SET x2
CONJUNTO DE PATAS x2
GLOSSY SILVER / PLATA BRILLO



3,5x3,5x27 CM / INCH 1.3x1.3x10.6

Mirrors and LED wall lamps

Espejos y apliques LED

B01001004 50 CM
B01001001 60 CM
B01001002 80 CM
B01001003 100 CM
B01001005 120 CM

MIRROR
 ESPEJO



50-60-80-100-120x80 CM / INCH 19.7-23.6-31.5-39.4-47.2x31.5

B01001006 60 CM
B01001007 80 CM
B01001008 100 CM
B01001009 120 CM

MIRROR
 ESPEJO



60/80/100/120x80 CM / INCH 23.6/31.5/39.4/47.2x31.5

B02007007 28 CM
B02008008 49,4 CM

LED WALL LAMP
 APLIQUE LED



› IP44 LEDS 1X6W - 4000k "NATURAL WHITE" - INPUT 240v
 28-49,4x10,7x2,9 CM / INCH 11-19.4x4.2x1.1

B02014014 80 CM
B02015015 100 CM

LED WALL LAMP
 APLIQUE LED



› IP44 LEDS 1X10-1X15 - 4000k "NATURAL WHITE" - INPUT 220V
 80-100x10,7x2,9 CM / INCH 31.5-39.4x4.2x1.1

Everything about Bath+ makes sense and provides continuity. The straight clear lines of the mirrors in this collection mean that they adapt perfectly to furniture of all shapes and sizes. That's how you feel you are in an ample yet cosy place.

mirrors

En Bath+ todo tiene un sentido y una continuidad. De líneas rectas y nítidas, los espejos de esta colección se adaptan a la perfección a los distintos anchos de mueble. De este modo se consigue sensación de amplitud en espacios que transmiten comodidad.







**SIMPLE RECTANGULAR OR ROUND
MIRRORS THAT ADAPT TO ANY
ENVIRONMENT**

ESPEJOS BÁSICOS, RECTANGULARES
O REDONDOS, QUE SE ADAPTAN A
CUALQUIER ENTORNO

B01001004
MIRROR
ESPEJO



50x80 CM / INCH 19.7x31.5

B01001001
MIRROR
ESPEJO



60x80 CM / INCH 23.6x31.5

B01001002
MIRROR
ESPEJO



80x80 CM / INCH 31.5x31.5

B01001003
MIRROR
ESPEJO



100x80 CM / INCH 39.4x31.5

B01001005
MIRROR
ESPEJO



120x80 CM / INCH 47.2x31.5

B01001006
MIRROR
ESPEJO



◆
40 CM / INCH 15.7

B01001007
MIRROR
ESPEJO



◆
60 CM / INCH 23.6

B01001008
MIRROR
ESPEJO



◆
80 CM / INCH 31.5

B01001009
MIRROR
ESPEJO



◆
100 CM / INCH 39.4

The LED appliances available in the collection adhere to the Bath+ philosophy of respecting the surroundings. They are also noteworthy because of their discreet appearance, aimed at real bathrooms with no airs and graces.

lighting

Los apliques led de Bath+ siguen la filosofía de ser respetuosos con el entorno. También destacan por su estética discreta para baños reales, sin pretensiones ni artificios



B02007007
LED WALL LAMP
APLIQUE LED



⦿
› □ IP44 LEDS 1X6W - 4000k "NATURAL WHITE" - INPUT 240v
28x10,7x2,9 CM / INCH 11x4.2x1.1
CERTIFIED UL STD 1598

B02008008
LED WALL LAMP
APLIQUE LED



⦿
› □ IP44 LEDS 1X6W - 4000k "NATURAL WHITE" - INPUT 240v
49,4x10,7x2,9 CM / INCH 19.4x4.2x1.1
CERTIFIED UL STD 1598

B02014014
LED WALL LAMP
APLIQUE LED



⦿
› □ IP44 LEDS 1X10 - 4000k "NATURAL WHITE" - INPUT 220V
80x10,7x2,9 CM / INCH 31.5x4.2x1.1

B02015015
LED WALL LAMP
APLIQUE LED



⦿
› □ IP44 LEDS 1X15 - 4000k "NATURAL WHITE" - INPUT 220V
100x10,7x2,9 CM / INCH 39.4x4.2x1.1

BATH+

BY COSMIC

BASIC MOUNTING SET
KIT SUJECIÓN BÁSICO

3410765

ADHESIVE KIT
KIT ADHESIVO

3410766

ADHESIVE KIT
KIT ADHESIVO

3410589

DISPENSER PUMP
BOMBA DOSIFICADOR

3410682

SOAP DISH
JABONERA

3410585

SHELF
ESTANTE

3410587

40 CM / INCH 15.7

3410588

60 CM / INCH 23.6

TUMBLER MATTE GLASS
VASO VIDRIO MATE

3410584

TOILET BRUSH STICK WITH BRUSH
PALO ESCOBILLERO CON CEPILLO

3410582 (duo 26_0100)

3410583 (duo 26_0101)

DISPENSER PUSH BUTTON + PUMP
PULSADOR + BOMBA DOSIFICADOR

3410615

DRYWALL ANCHOR
TACO PLADUR

3410639

UX-R Ø6X35MM

BLACK BRUSH FOR GLASS TOILET BRUSH
CEPILLO NEGRO PARA ESCOBILLERO VIDRIO

B030031

TOILET BRUSH BRUSH BLACK
CEPILLO ESCOBILLERO NEGRO

B030032

FLANGE
EMBELLECEDOR

3410652

line SPARE PARTS RECAMBIOS

TOILET BRUSH STICK WITH BRUSH
PALO ESCOBILLERO CON CEPILLO

3410752

TOILET BRUSH
CEPILLO ESCOBILLERO

3410753

ADHESIVE KIT
KIT ADHESIVO

3410754

DISPENSER PUSH BUTTON + PUMP
PULSADOR + BOMBA DOSIFICADOR

3410755

DISPENSER PUMP
BOMBA DOSIFICADOR

3410756

MOUNTING SET
ACCESORIO SUJECIÓN

3410757

VERTICAL FLANGE WITH LOGO
EMBELLECEDOR VERTICAL CON LOGO

3410758

HORIZONTAL FLANGE WITH LOGO
EMBELLECEDOR HORIZONTAL CON LOGO

3410759

FLANGE WITHOUT LOGO
EMBELLECEDOR SIN LOGO

3410760

ADHESIVE KIT-PAPER HOLDER WITH COVER
KIT ADHESIVO-PORTA PAPEL CON TAPA

3410761

MOUNTING SET
ACCESORIO SUJECIÓN

3410762

WASTE BIN FLANGE
EMBELLECEDOR PAPELERA

3410763

SQUARE ADHESIVE KIT
SET ADHESIVO CUADRADO

3410767

RECTANGLE ADHESIVE KIT
SET ADHESIVO RECTANGULAR

3410768

WHITE TOILET BRUSH STICK WITH BRUSH
PALO ESCOBILLERO BLANCO

3410769

BLACK TOILET BRUSH STICK WITH BRUSH
PALO ESCOBILLERO NEGRO

3410770

CHROME TOILET BRUSH STICK WITH BRUSH
PALO ESCOBILLERO CROMO CON CEPILLO

3410582

CHROME DISPENSER PUSH BUTTON + PUMP
PULSADOR Y BOMBA CROMO

3410771

WHITE DISPENSER PUSH BUTTON + PUMP
PULSADOR Y BOMBA BLANCO

3410772

BLACK DISPENSER PUSH BUTTON + PUMP
PULSADOR Y BOMBA NEGRO

3410773

DISPENSER PUMP
BOMBA DOSIFICADOR

3410682

BRUSH FOR GLASS TOILET BRUSH
CEPILLO PARA ESCOBILLERO DE VIDRIO

B030031

DISPLAYS 60x150 CM / INCH 23.6x59.2

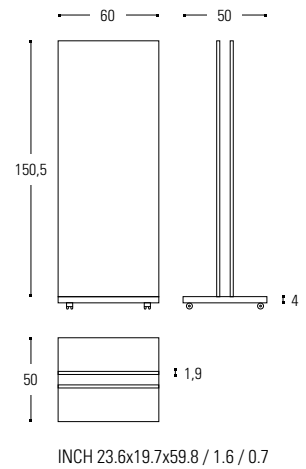

EXPOSITOR TOTEM
TOTEM DISPLAY
326 70 03

DISPLAYS 60x150 CM / INCH 23.6x59.2



B0004005
DUO ROUND GLASS
DUO ROUND VIDRIO

60x1,9x150,5 CM / INCH 23.6x0.7x59.2



B0004006
DUO SQUARE GLASS
DUO SQUARE VIDRIO

60x1,9x150,5 CM / INCH 23.6x0.7x59.2



B0004007
DUO ROUND CHROME
DUO ROUND CROMO

60x1,9x150,5 CM / INCH 23.6x0.7x59.2



B0004008
DUO SQUARE CHROME
DUO SQUARE CROMO

60x1,9x150,5 CM / INCH 23.6x0.7x59.2



B0004009
DUO SQUARE SHELF
 DUO SQUARE ESTANTE

60x1,9x150,5 CM / INCH 23.6x0.7x59.2



B0004010
DUO SOAP DISH
 DUO JABONERAS

60x1,9x150,5 CM / INCH 23.6x0.7x59.2



B0004011
LINE

60x1,9x150,5 CM / INCH 23.6x0.7x59.2



B0004012 STICK CHROME / CROMO
B0004014 STICK BLACK / NEGRO
B0004015 STICK WHITE / BLANCO

60x1,9x150,5 CM / INCH 23.6x0.7x59.2

DISPLAYS 60x150 CM / INCH 23.6x59.2



B0004013
LINE+STICK

60x1,9x150,5 CM / INCH 23.6x0.7x59.2

DISPLAYS 60x75 CM / INCH 23.6x29.5

CODE
CODIFICACIÓN

B0002007 EN EN ENGLISH
B0002007 —

COLLECTION
COLECCIÓN

LANGUAGE
IDIOMA

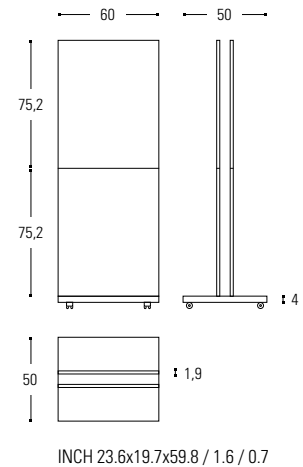

EXPOSITOR TOTEM
TOTEM DISPLAY

326 70 03

DISPLAYS 60x75 CM / INCH 23.6x29.5



B0002005
DUO ROUND GLASS
DUO ROUND VIDRIO

60x1,9x75 CM / INCH 23.6x0.7x29.5



B0002006
DUO SQUARE GLASS
DUO SQUARE VIDRIO

60x1,9x75 CM / INCH 23.6x0.7x29.5



B0002007
DUO ROUND CHROME
DUO ROUND CROMO

60x1,9x75 CM / INCH 23.6x0.7x29.5



B0002008
DUO SQUARE CHROME
DUO SQUARE CROMO

60x1,9x75 CM / INCH 23.6x0.7x29.5



B0002011
LINE

60x1,9x75 CM / INCH 23.6x0.7x29.5



B0002013XX BLACK / NEGRO
B0002016XX GRAY / GRIS
DIABOLO

60x1,9x75 CM / INCH 23.6x0.7x29.5



B0002012 STICK CHROME / CROMO
B0002014 STICK BLACK / NEGRO
B0002015 STICK WHITE / BLANCO

60x1,9x75 CM / INCH 23.6x0.7x29.5

EXPORT GENERAL SALES CONDITIONS

- 1** Las ventas de INDUSTRIAS COSMIC, S.A.U. se realizan según las condiciones generales aquí expuestas y la entrega de cualquier pedido supone la aceptación, por parte del comprador, de dichas condiciones generales de venta.
- 2** Los productos se pueden modificar, reemplazar o suprimir en todo momento y la información de cualquier naturaleza contenida en nuestros catálogos, tarifas o material publicitario es indicativa.
- 3** Los pedidos recibidos directamente de los clientes o realizados por nuestros representantes en nombre de ellos siempre estarán sujetos a nuestra aceptación. INDUSTRIAS COSMIC, S.A.U. da por confirmados todos los pedidos recibidos y, si no hay notificación específica se entenderán como aceptados.
- 4** Ningún pedido aceptado por nosotros se podrá retractar ni anular sin nuestra aceptación. El cliente, por su parte, no podrá efectuar ninguna devolución de mercancía sin nuestro consentimiento previo. En el caso de anulación o modificación por parte del cliente y por causas ajenas a INDUSTRIAS COSMIC, S.A.U., de un pedido que ya haya sido expedido, se facturará al cliente en concepto de gastos de gestión un importe de 30€ netos (IVA no incluido) para pedidos de accesorios y 50€ netos (IVA no incluido) en caso de mobiliario.
- 5** Forfait gastos de gestión y transporte:
España peninsular, 5€ para pedidos inferiores a 50€ netos
Baleares, Andorra y Portugal, 20€ para pedidos inferiores a 400€ netos
Canarias 60€ para pedidos inferiores a 400€ netos
Forfait aduana:
Andorra 30€ x pedido
Canarias 30€ x pedido, despacho de destino e impuestos insulares, por cuenta del destinatario.
Nuestras mercancías serán facturadas según la última tarifa aplicable en el momento del envío. Los precios de esta tarifa no incluyen el IVA.
- 6** INDUSTRIAS COSMIC, S.A.U. ofrece una garantía de 3 años, excepto en los casos indicados en la tarifa, contra todos los defectos de materia prima y fabricación válida a partir del momento de adquisición por parte del cliente final. A fin de determinar la fecha de adquisición será imprescindible la presentación de la factura de compra. Esta garantía consistirá en la sustitución de la pieza que determine su irregular funcionamiento, salvo por razones de uso inadecuado, montaje o instalación incorrectos, mantenimiento indebido, desgaste del uso diario o defectos provocados por reacciones químicas, electroquímicas o eléctricas. La garantía excluye de responsabilidad a INDUSTRIAS COSMIC, S.A.U. de todas las consecuencias derivadas del funcionamiento o instalación de nuestros productos y esta no reconoce ninguna indemnización por la sustitución de artículos defectuosos ni demanda por daños y perjuicios.
- 7** Nuestras mercancías viajan aseguradas y, en caso de rotura, avería o recepción incompleta del envío, el cliente deberá indicarlo en el albarán de entrega del transporte e informar por escrito a INDUSTRIAS COSMIC, S.A.U. en las 24 horas siguientes a la recepción de la mercancía para poder ejercer la reclamación al transportista.
- 8** INDUSTRIAS COSMIC, S.A.U. intenta siempre reducir al máximo los tiempos de servicio al cliente, ajustándose en lo posible a los requisitos de plazo solicitados expresamente en el pedido y, en caso de no poder satisfacerlos, se enviará una notificación.
- 9** Los productos marca COSMIC, objeto de pedido, se entregarán bajo reserva de dominio a favor de INDUSTRIAS COSMIC, S.A.U. hasta el total cumplimiento de las obligaciones de pago por parte del comprador.
- 10** En caso de impagados, se incurre en un cargo por devolución, más los gastos de financiación actuales en el mercado. INDUSTRIAS COSMIC, S.A.U. se reserva el derecho de retener los pedidos en curso hasta solucionar los efectos pendientes.
- 11** Las disputas referentes a la interpretación o a la ejecución de estas condiciones generales de venta pasarán a ser competencia de los tribunales de nuestra jurisdicción.
- 12** COSMIC aporta la Información de las certificaciones que cumplimos como fabricantes. Es responsabilidad de los instaladores conocer las certificaciones necesarias en cada país.

CONDICIONES GENERALES DE VENTA ESPAÑA

- 1** Las ventas de INDUSTRIAS COSMIC, S.A.U. se realizan según las condiciones generales aquí expuestas y la entrega de cualquier pedido supone la aceptación, por parte del comprador, de dichas condiciones generales de venta.
- 2** Los productos se pueden modificar, reemplazar o suprimir en todo momento y la información de cualquier naturaleza contenida en nuestros catálogos, tarifas o material publicitario es indicativa.
- 3** Los pedidos recibidos directamente de los clientes o realizados por nuestros representantes en nombre de ellos siempre estarán sujetos a nuestra aceptación. INDUSTRIAS COSMIC, S.A.U. da por confirmados todos los pedidos recibidos y, si no hay notificación específica se entenderán como aceptados.
- 4** Ningún pedido aceptado por nosotros se podrá retractar ni anular sin nuestra aceptación. El cliente, por su parte, no podrá efectuar ninguna devolución de mercancía sin nuestro consentimiento previo. En el caso de anulación o modificación por parte del cliente y por causas ajenas a INDUSTRIAS COSMIC, S.A.U., de un pedido que ya haya sido expedido, se facturará al cliente en concepto de gastos de gestión un importe de 30€ netos (IVA no incluido) para pedidos de accesorios y 50€ netos (IVA no incluido) en caso de mobiliario.
- 5** Forfait gastos de gestión y transporte:
España peninsular, 5€ para pedidos inferiores a 50€ netos
Baleares, Andorra y Portugal, 20€ para pedidos inferiores a 400€ netos
Canarias 60€ para pedidos inferiores a 400€ netos
Forfait aduana:
Andorra 30€ x pedido
Canarias 30€ x pedido, despacho de destino e impuestos insulares, por cuenta del destinatario.
Nuestras mercancías serán facturadas según la última tarifa aplicable en el momento del envío. Los precios de esta tarifa no incluyen el IVA.
- 6** INDUSTRIAS COSMIC, S.A.U. ofrece una garantía de 3 años, excepto en los casos indicados en la tarifa, contra todos los defectos de materia prima y fabricación válida a partir del momento de adquisición por parte del cliente final. A fin de determinar la fecha de adquisición será imprescindible la presentación de la factura de compra. Esta garantía consistirá en la sustitución de la pieza que determine su irregular funcionamiento, salvo por razones de uso inadecuado, montaje o instalación incorrectos, mantenimiento indebido, desgaste del uso diario o defectos provocados por reacciones químicas, electroquímicas o eléctricas. La garantía excluye de responsabilidad a INDUSTRIAS COSMIC, S.A.U. de todas las consecuencias derivadas del funcionamiento o instalación de nuestros productos y esta no reconoce ninguna indemnización por la sustitución de artículos defectuosos ni demanda por daños y perjuicios.
- 7** Nuestras mercancías viajan aseguradas y, en caso de rotura, avería o recepción incompleta del envío, el cliente deberá indicarlo en el albarán de entrega del transporte e informar por escrito a INDUSTRIAS COSMIC, S.A.U. en las 24 horas siguientes a la recepción de la mercancía para poder ejercer la reclamación al transportista.
- 8** INDUSTRIAS COSMIC, S.A.U. intenta siempre reducir al máximo los tiempos de servicio al cliente, ajustándose en lo posible a los requisitos de plazo solicitados expresamente en el pedido y, en caso de no poder satisfacerlos, se enviará una notificación.
- 9** Los productos marca COSMIC, objeto de pedido, se entregarán bajo reserva de dominio a favor de INDUSTRIAS COSMIC, S.A.U. hasta el total cumplimiento de las obligaciones de pago por parte del comprador.
- 10** En caso de impagos, se incurre en un cargo por devolución, más los gastos de financiación actuales en el mercado. INDUSTRIAS COSMIC, S.A.U. se reserva el derecho de retener los pedidos en curso hasta solucionar los efectos pendientes.
- 11** Las disputas referentes a la interpretación o a la ejecución de estas condiciones generales de venta pasarán a ser competencia de los tribunales de nuestra jurisdicción.
- 12** COSMIC aporta la Información de las certificaciones que cumplimos como fabricantes. Es responsabilidad de los instaladores conocer las certificaciones necesarias en cada país.

MATERIALS



PRESSED GLASS

(glasses and soap dishes in most collections)

A very similar material to the FLOAT glass used for the shelves, glasses, and soap dishes, etc. This molten glass is shaped in a mould. These products should be used and cared for in the same way as the shelves and washbasin tops. 100% recyclable.



MIRRORS

Sheet of glass covered by layers of silver, copper and, finally, paint. The use of topquality raw materials in conjunction with the correct mirror manufacturing process guarantee maximum protection against stains caused by corrosion.



PVC

Polyvinyl chloride (PVC) is a polyvinyl chloride polymer used to manufacture numerous products and is also applied in making boards, panels, windows, shutters, etc. Its durability, colour stability, watertightness and moisture proof properties make PVC an ideal material for bathroom and kitchen furniture. The material can be cleaned quickly and easily with just soap and water, although its resilience means most cleaning products can also be used.



PLASTIC

We use various technical plastics with different features to meet the manufacturing and aesthetic needs of each product. These include ABS (with or without chrome), PP, PA, PE, PC, PS, etc.



STAINLESS STEEL

It is an alloy of iron and carbon. Steel maintains the iron hardness characteristics. This steel has a special chrome treatment against the rust and oxidation. The used alloys are SS201 & SS304.



BRASS OR SIMILAR ALLOYS

(glossy chrome and matt chrome)

A copper and zinc alloy—this is one of the non-ferrous metals, the proportion of which varies according to its use. It offers greater malleability than both copper and zinc separately, and it is easily refined which allows for a high level of design customization.



ALUMINUM

Aluminium alloy. May be presented as solid, extruded and calibrated. Aluminium is an important metal for numerous industries, such as the automotive industry where it is most common. It is generally a soft metal with low melting points.



PORCELAIN

Ceramic product obtained from a sophisticated paste made up of kaolin, feldspar and quartz. Porcelain is treated with a vitrified top finish for surface hardness, colour and sheen. It is non-porous and hygienic, which makes it suitable for use in the bathroom. The vitrified finish means that it can be cleaned with any bathroom-specific product.



MELAMINE (MELAMINE PAPER)

Decorative sheet with a mixture of melamine resins applied to the board (agglomerated or medium density) using pressure and temperature, obtaining a highly consistent, scratch resistant surface. Our designs allow us to obtain surfaces that reproduce the beauty of the wood and lacquer.



COMPOSITE

A material comprised of 75% natural minerals (calcium carbonate and aluminium trihydrate) mixed with 25% polyester resin. The gel coating provides a surface that is highly durable, elegant to the touch and extremely hygienic.



POLYESTER

Synthetic fibre widely used in the textile industry. Very resistant and durable, it maintains its colour over time. Cleaning this material is quick and easy: water and mild soap so as not to damage the original colour of the rope.

MATERIALES



VIDRIO PRENSADO

(Vasos y jaboneras de la mayoría de nuestras series)
Material muy similar al vidrio FLOAT utilizado en estantes, vasos, jaboneras... Este vidrio fundido es conformado en un molde. El uso y cuidados deben ser los mismos que para estantes y encimeras. 100% reciclable.



ESPEJOS

Plancha de vidrio sobre la que se aplica una capa de plata, cobre y finalmente pintura. El uso de materia prima de primera calidad, unido a un correcto proceso de fabricación de los espejos, aseguran la mayor protección contra las manchas por corrosión.



PVC

El cloruro de polivinilo (PVC) es un polímero de cloruro de vinilo que se emplea para la fabricación de multitud de productos, encontrando aplicación en la realización de tableros, paneles, ventanas, persianas, etc. La larga durabilidad, estabilidad del color, estanqueidad al agua y resistencia a la humedad, son las características que hacen del PVC un material idóneo para muebles de baño y de cocina. La limpieza de este material es fácil y rápida y se realiza con agua y jabón, aunque por su resistencia permite el empleo la mayoría de productos de limpieza.



PLÁSTICO

Cosmic utiliza plásticos técnicos de distintas características en función de las necesidades de fabricación y estéticas de cada producto o pieza. Entre los plásticos utilizados están: ABS (cromado o no), PP, PA, PE, PC, PS, etc.



ACERO INOXIDABLE

Aleación de hierro con carbono que conserva las propiedades de dureza del hierro. Se trata de un acero con un tratamiento especial de cromo, contra la corrosión y oxidación. Las aleaciones utilizadas son la SS303 y SS304.



LATÓN O ALEACIONES ANÁLOGAS (cromo brillante y cromo mate)

Aleación de cobre y zinc, es uno de los metales no férricos, cuya proporción varía en función de su aplicación. Destaca su maleabilidad, más alta que la del cobre y zinc por separado, y fácil pulido lo cual permite un alto grado de adaptación en el diseño de las piezas.



ALUMINIO

Aleación de aluminio. Se puede presentar como macizo extrusionado, estirado y calibrado. El aluminio es un metal importante para una gran cantidad de industrias, como la del automóvil, donde se utiliza habitualmente. Tiende a ser blando y presenta puntos de fusión bajos.



PORCELANA

Producto cerámico que se obtiene a partir de una pasta muy elaborada compuesta por caolín, feldespato y cuarzo. La porcelana es tratada con un acabado final vitrificado que da a la superficie la dureza superficial, color, brillo, no porosidad e higiene idóneos para su uso en el baño. Este vitrificado permite limpiarla con cualquier producto destinado a la limpieza del baño.



MELAMINA (PAPEL MELAMÍNICO)

Lámina decorativa con una mezcla de resinas melamínicas aplicadas sobre el tablero (aglomerado o DM) mediante presión y temperatura, obteniendo una superficie de alta consistencia que resiste el rayado. Nuestros diseños permiten conseguir superficies que reproducen la belleza de la madera y los lacados.



COMPOSITE

Material compuesto de minerales naturales en un 75% (carbonato de calcio y trihidratos de aluminio) mezclado con un 25% de resina de poliéster. La película de gel coat que recubre la superficie permite obtener una superficie de excelente resistencia, elegante al tacto y altamente higiénico.



POLIÉSTER

Fibra sintética ampliamente usada en la industria textil. Muy resistente y duradera, mantiene su color a lo largo del tiempo. La limpieza de este material es fácil y rápida: con agua y un jabón neutro para no dañar el color original de la cuerda.

BATH+

BY COSMIC

BATH+

BATH+